

Projector

CP-X2011N/CP-X2511N /CP-X3011N/CP-X4011N

User's Manual (detailed) Network Guide

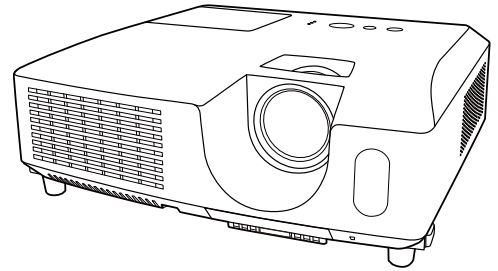

Thank you for purchasing this product.

This manual is intended to explain only the network function. For proper use of this product, please refer to this manual and the other manuals for this product.

⚠ WARNING ▶ Before using this product, be sure to read all manuals for this product. After reading them, store them in a safe place for future reference.

Features

This projector has the network function that brings you the following main features.

- ✓ **Network Presentation** : allows the projector to project computer images transmitted through a network. (📖37)
- ✓ **Web Control** : allows you to monitor and control the projector through a network from a computer. (📖45)
- ✓ **My Image** : allows the projector to store up to four still images and project them. (📖70)
- ✓ **Messenger** : allows the projector to display text sent from a computer through a network. (📖72)
- ✓ **Network Bridge** : allows you to control an external device through the projector from a computer. (📖74)

NOTE • The information in this manual is subject to change without notice.
• The manufacturer assumes no responsibility for any errors that may appear in this manual.
• The reproduction, transfer or copy of all or any part of this document is not permitted without express written consent.

Trademark acknowledgment

- Microsoft and Internet Explorer, Windows, Windows Vista are registered trademark of Microsoft Corporation.
 - Pentium is a registered trademark of Intel Corporation.
 - JavaScript is a registered trademark of Sun Microsystems, Inc.
 - HDMI, the HDMI logo and High-Definition Multimedia Interface are trademarks or registered trademarks of HDMI Licensing LLC in the United States and other countries.
 - Trademark PJLink is a trademark applied for trademark rights in Japan, the United States of America and other countries and areas.
- All other trademarks are the properties of their respective owners.

PJLink[™]



1. Connection to the Network	4
1.1 System requirements	4
1.1.1 Required equipment preparation	4
1.1.2 Hardware and software requirement for computer	4
1.2 Installing the “LiveViewer”	6
1.2.1 Installing the “LiveViewer”	6
1.2.2 Updating the “LiveViewer”	7
1.3 Process to connect the network	8
1.3.1 Process overview	8
1.3.2 Starting the “LiveViewer”	9
1.4 Selecting the network connection mode	10
1.4.1 Selecting either the wireless LAN or wired LAN	10
1.4.2 Selecting My Connection	12
1.5 Selecting the network connection method	14
1.5.1 Passcode connection	15
1.6 Manual Configuration	23
1.6.1 Profile connection	23
1.6.2 History connection	24
1.7 Configuring the network settings manually	25
1.8 Confirming the connection to your destination	30
1.8.1 Connection and transmission	30
1.8.2 Connection error	32
1.9 Profile data	33
1.9.1 Outline of Profile data	33
1.9.2 Making Profile data	33
1.9.3 Editing Profile data	34
1.9.4 Registering My Connection	35
2. Network Presentation	37
2.1 Using the “LiveViewer”	37
2.1.1 Main menu and Operating buttons	37
2.1.2 Displaying the status	39
2.1.3 Switching the display mode	40
2.1.4 Option menu	41
2.2 Starting the Network Presentation	43
2.2.1 Display mode	43
2.2.2 Presenter mode	44
2.2.3 Display User Name	44



3. Web Control	45
3.1 Logon	46
3.2 Network Information	48
3.3 Network Settings	49
3.4 Port Settings	50
3.5 Mail Settings	52
3.6 Alert Settings	53
3.7 Schedule Settings	55
3.8 Date/Time Settings	58
3.9 Security Settings	60
3.10 Projector Control	61
3.11 Remote Control	67
3.12 Projector Status	68
3.13 Network Restart	69
4. My Image Function	70
5. Messenger Function	72
6. Network Bridge Function	74
6.1 Connecting devices	74
6.2 Communication setup	75
6.3 Communication port	75
6.4 Transmission method	76
6.4.1 HALF-DUPLEX	76
6.4.2 FULL-DUPLEX	77
7. Other Functions	78
7.1 E-mail Alerts	78
7.2 Projector Management using SNMP	80
7.3 Event Scheduling	81
7.4 Command Control via the Network	84
8. Troubleshooting	89
9. Warranty and after-sales service	92

1. Connection to the network

1.1 System requirements

1.1.1 Required equipment preparation



The following equipments are required to connect the projector to your computer through the network.

- ✓ **Projector**
- ✓ **LAN cable** (to connect the projector to a network): CAT-5 or greater
- ✓ **Computer** (minimum 1 set): equipped with the network feature (100Base-TX or 10Base-T)

1.1.2 Hardware and software requirement for computer

The “LiveViewer” software needs to be installed on all the computers to connect to the projector through a network. To use the “LiveViewer” your computer needs to meet the following requirements.

- ✓ **OS:** One of the following.
Windows[®] XP Home Edition /Professional Edition (32 bit version only)
Windows Vista[®] Home Basic /Home Premium /Business /Ultimate /Enterprise (32 bit version only)
- ✓ **CPU:** Pentium 4 (2.8 GHz or higher)
- ✓ **Graphic card:** 16 bit, XGA or higher
- * When using the “LiveViewer” it is recommended that the display resolution of your computer is set to 1024 x 768.
- ✓ **Memory:** 512 MB or higher
- ✓ **Hard disk space:** 30 MB or higher
- ✓ **Web browser:** Internet Explorer[®] 6.0 or higher
- ✓ **CD-ROM drive**

NOTE • The network communication control is disabled while the projector is in standby mode if the STANDBY MODE item is set to SAVING. Please connect the network communication to the projector after setting the STANDBY MODE to NORMAL. ( **SETUP menu in the User’s Manual – Operating Guide**)
• You can get the latest version of the “LiveViewer” and the latest information for this product from our website. ( 7)

1.1 System requirements (continued)

- NOTE** • Set your computer's resolution to XGA or less. Refer to the user manual for your computer or Windows. If it is larger than XGA, the transmission speed will be reduced.
- If you use a screen resolution greater than XGA, the projector will shrink it to XGA on screen.
 - Images might not be transmitted, caused by OS version or the driver software for Network Adapter on your computers. It is highly recommended that OS and the driver should be updated to the latest.

1.2 Installing the “LiveViewer”

1.2.1 Installing the “LiveViewer”

The “LiveViewer” software needs to be installed on all the computers to connect to the projector through a network.

If your OS is Windows XP or Vista, you need to log in as an administrator user to install the software.

- 1) Turn on the computer.
- 2) Shut down all applications.
- 3) Insert the accompanying CD-ROM into the computer's CD-ROM drive.

NOTE • After sequence 3), the User Account Control (UAC) dialog will appear (if you are using Windows Vista). Please click the **[Allow]** to continue installation.

- 4) After a moment, the Choose Setup Language dialog will appear as shown on the right. Select what you like to use in the list, and click the **[OK]**.

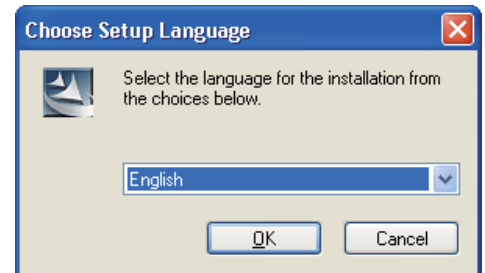

NOTE • If the Choose Setup Language dialog doesn't appear, proceed as follows:

- (1) Click on the **[Start]** button on the toolbar and select the “Run”.
- (2) Enter **E:\software\setup.exe** and then press the **[OK]**.

↑
If your CD-ROM drive is not drive E on your computer, you will need to replace E with the correct drive letter assigned to your CD-ROM drive.

If the software has been already installed, Uninstallation will be done. Click the **[Cancel]** button, then uninstallation will be canceled. If you uninstalled the software by miss-operation, please re-install the software from first procedure.

- 5) After a moment, the Welcome dialog will appear as shown on the right. Press the **[Next]**.

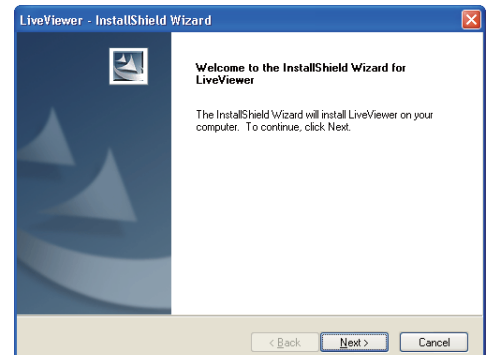

1.2 Installing the “LiveViewer” (continued)

- 6) The License Agreement dialog appears. If you accept it, select “I accept the terms of the license agreement” and press the **[Next]**.
- 7) The Choose Destination Location dialog appears. Press the **[Next]**.

NOTE • The C:\Program Files\Projector Tools\LiveViewer folder will be created and the program will be installed into that folder. If you wish to install to a different folder, click the **[Browse]** and select another folder.

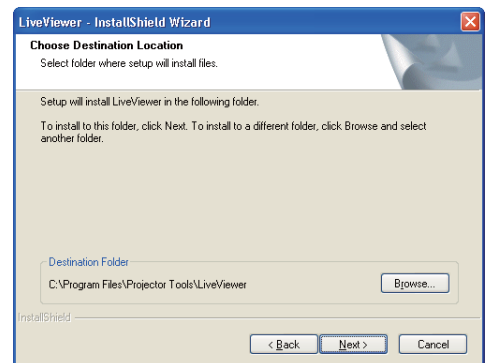
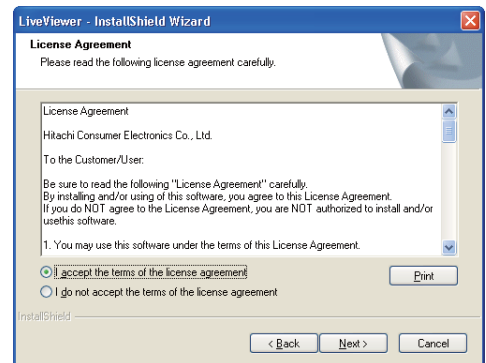

- 8) Confirm the program folder name. If “Projector Tools” is okay, press the **[Next]** to continue. If not, enter the desired folder name and then press the **[Next]**.
- 9) The Hardware Installation dialog appears. Press Continue Anyway.

NOTE • After sequence 8), the Windows Security dialog will appear if you are using Windows Vista. Please click the **[Install this driver software anyway]** and continue installation.

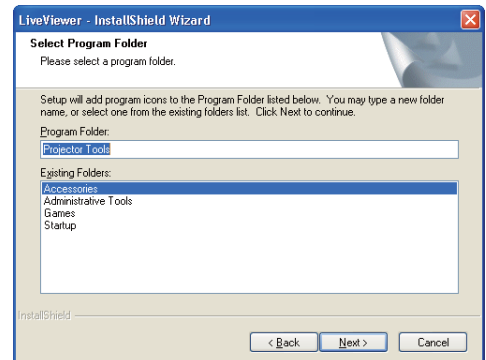

- 10) After a moment, installation will complete and the Setup Complete dialog will appear as shown on the right. Click the **[Finish]**. This completes the software installation. Then your computer automatically restarts.
- (1) To confirm that the software has been properly installed, press the **[Start]** button on the toolbar, select All Programs and then select the Projector Tools folder.
- (2) The “LiveViewer” will appear in that folder if the installation was successful.

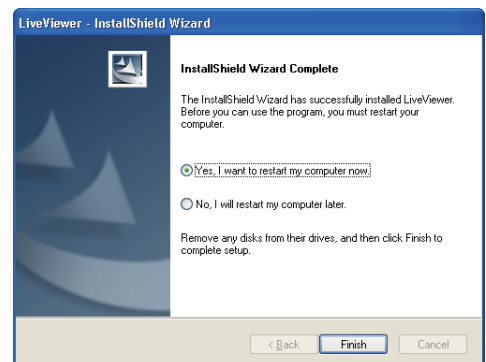

1.2.2 Updating the “LiveViewer”

Please check and get the latest version at Hitachi Web site.

<http://hitachi.us/digitalmedia> or <http://www.hitachidigitalmedia.com>

Some functions explained in this manual require the “LiveViewer” Version 4.xx. (In the version information a number between 00 and 99 will replace the xx.)

1.3 Process to connect the network

Before connecting your computer and projector via a network, make sure that the LAN port is selected as the input source on the projector. ([📖 Operating in the User's Manual – Operating Guide](#)) Otherwise a connection cannot be established.

1.3.1 Process overview

An overview of the process to connect your computer and the projector via a network is shown below.

The “LiveViewer” allows you to skip some of the steps below to establish a network connection quickly and easily.

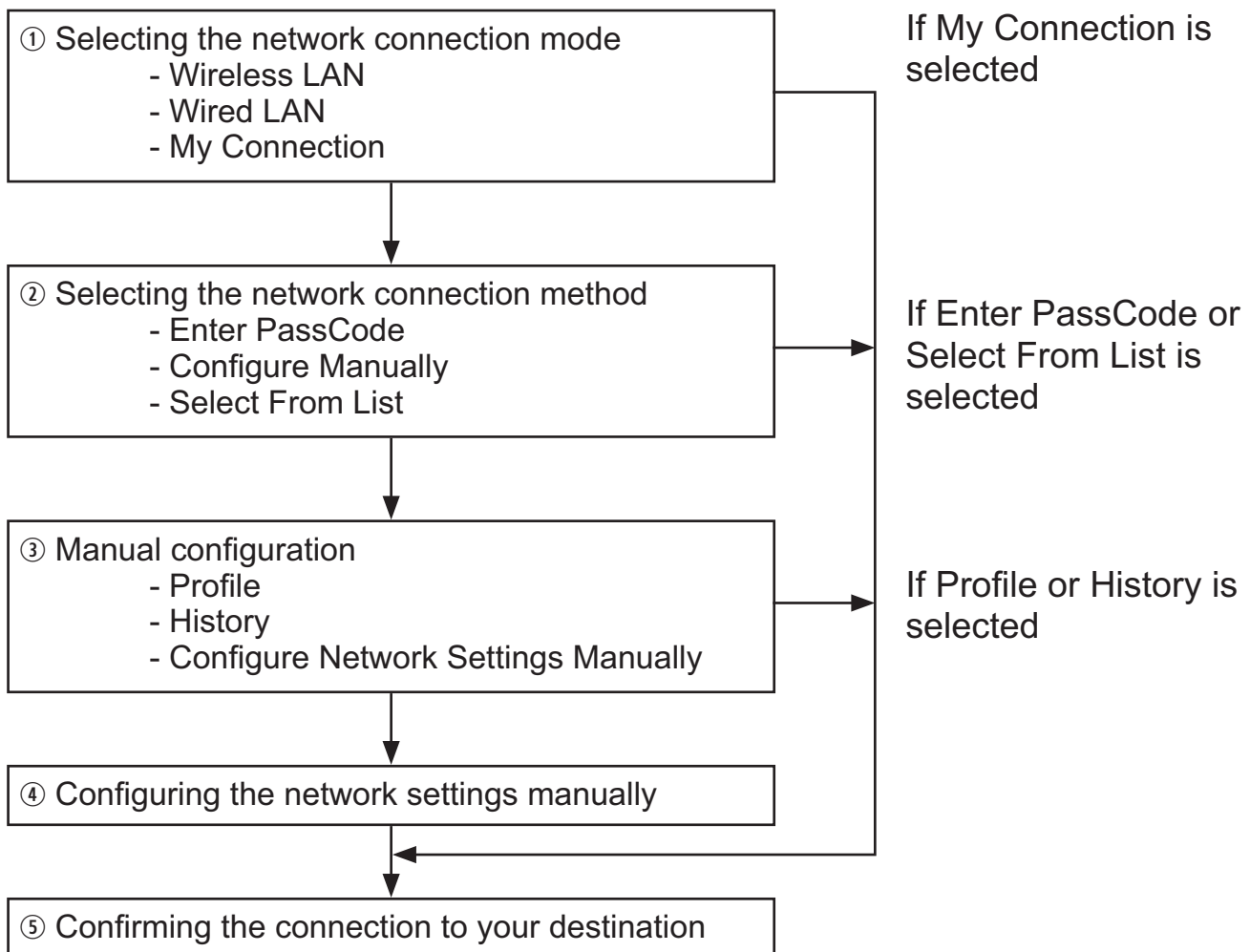

NOTE • Wireless LAN can be selected only when an access point to convert wireless LAN to wired LAN exists between your computer and the projector.

1.3 Process to connect the network (continued)

1.3.2 Starting the “LiveViewer”

Start the “LiveViewer” in your computer, taking one of the followings.

- 1) Double click the “LiveViewer” icon on the Desktop in your computer
- 2) Select “Start” → “All Programs” → “Projector Tools” → “LiveViewer” on Windows menu.

Then, proceed to item **1.4 Selecting the network connection mode.** ( 10)

1.4 Selecting the network connection mode

After starting the “LiveViewer”, the “Select the Network Connection” screen comes up. Select the network connection that you would like to use. There are 3 options in the menu.

- Wireless LAN
- Wired LAN
- My Connection

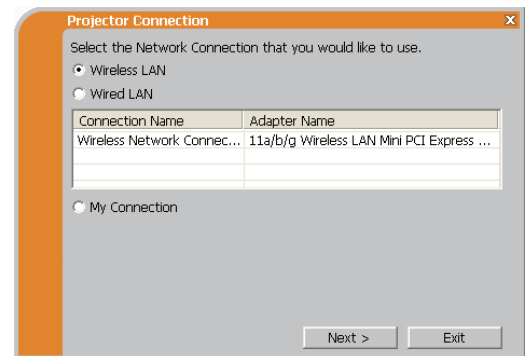

If you select either the wireless LAN or wired LAN, proceed to item **1.4.1 Selecting either the wireless LAN or wired LAN.** ([📖 below](#))

If you select My Connection, jump to item **1.4.2 Selecting My Connection.** ([📖 12](#))

NOTE • This dialog will not be displayed if the computer has just one network adapter and no My Connection is registered. Proceed to item **1.5 Selecting the network connection method.** ([📖 14](#))

- Select Wireless LAN only when you connect the computer and the access point via wireless network and connect the access point and the projector via wired network, since the projector doesn't have wireless LAN function.

1.4.1 Selecting either the wireless LAN or wired LAN

If you select either the wireless LAN or wired LAN, a list of the network adapters in your computer is shown in the menu.

Select what you like to use in the list, and click the **[Next]**.

Then, proceed to item **1.5 Selecting the network connection method.** ([📖 14](#))

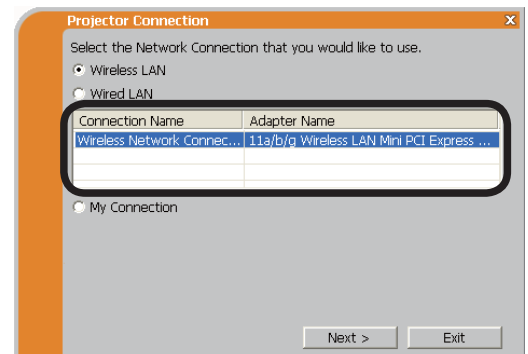

NOTE • If you select the wireless LAN, the wireless LAN adapters in your computer are shown in the list.

- If the wired LAN is selected, the wired LAN adapters in your computer are shown.

[Troubleshooting]

■ Are you sure that you want to turn on the network adapter?

The screen is displayed in the case that the selected network adapter is invalid.

- To turn it on, click the **[Yes]**, and then proceed to item **1.5.** ([📖 14](#))
- Not to turn it on, click the **[No]**, and then the screen is back to the previous one to select another network adapter. If no more adapter in your computer, the “LiveViewer” will be closed.

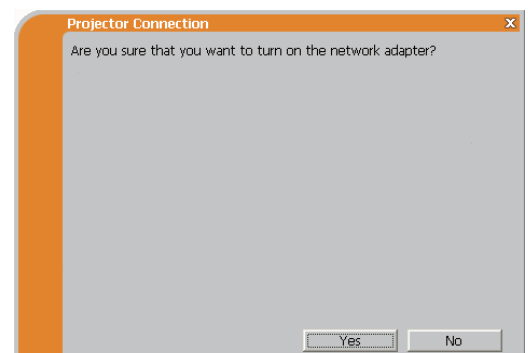

1.4 Selecting the network connection mode (continued)

■ A network connection was not established.

The screen is displayed in the case that the projector is not connected with a LAN cable to your computer when the wired LAN is selected.

Be sure that the projector is connected with a LAN cable to your computer.

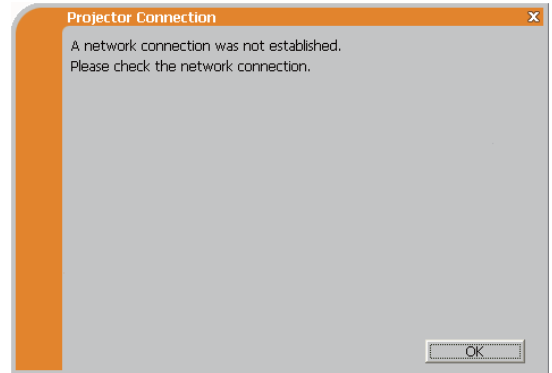

Click the **[OK]**, then the screen is back to the previous one to select the network connection mode.

■ Windows firewall is enabled (On).

The screen is displayed in the case that the firewall setting in Windows XP/Vista is activated, and the “LiveViewer” is blocked by the firewall.

- To turn it disabled (Off), click the **[Yes]**.
- Not to turn it disabled (Off), click the **[No]**, but the projector may not be able to communicate with your computer through the network.
- If you put a check mark in the **[Allow communication with LiveViewer by adding it to the Exceptions list]** box, the “LiveViewer” will never be blocked by Windows firewall.

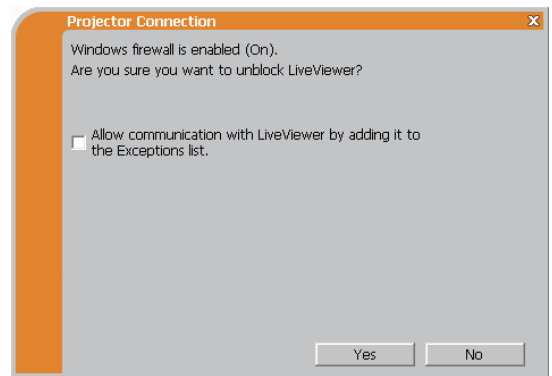

Proceed to item **1.5 Selecting the network connection method.** (📖14)

NOTE • If you click the **[Yes]**, the network access by the “LiveViewer” is temporarily permitted by Windows firewall, until the “LiveViewer” is closed.
 • If any application software having the firewall function is installed into you computer, make the firewall function invalid with following the user’s manual.

1. Connection to the network

1.4 Selecting the network connection mode (continued)

1.4.2 Selecting My Connection

Select the **[My Connection]** and click the **[Connect]**.

If you select the My Connection, the computer is connected to the projector through the network by using the profile data that is pre-assigned to My Connection. (📖35)

When you select the My Connection, the computer immediately starts the connection to the projector.

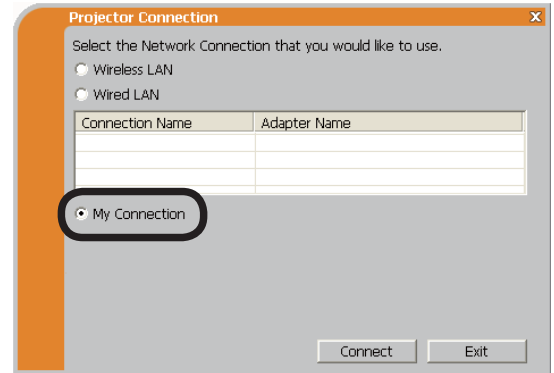

Proceed to item **1.8 Confirming the connection to your destination.** (📖30)

NOTE • If the DHCP is set on in the projector, the network connection between the projector and computer may not be established since IP address may be varied. If you like to use the My Connection, set the DHCP off in the projector.

- If no profile data is assigned to the My Connection, it can't be used.

[Troubleshooting]

■ A network connection could not be established.

Windows prevented network configuration changes.

You may log in the Windows under User authority.

Click the **[OK]** to return to the screen to select the network connection mode. (📖10)



Consult to the network administrator and log in again under the Administrator authority. After that, please resume at item **1.3.2 Starting the “LiveViewer”.** (📖9)

1.4 Selecting the network connection mode (continued)

■ Are you sure you want to connect the selected projector?

The message is appeared when the wireless adapter you selected is already used for another network connection.

- To connect, click the **[Yes]**. Proceed to item **1.8 Confirming the connection to your destination.** (📖30)
- Not to connect, click the **[No]** to return to the screen to select the network connection mode. (📖10)

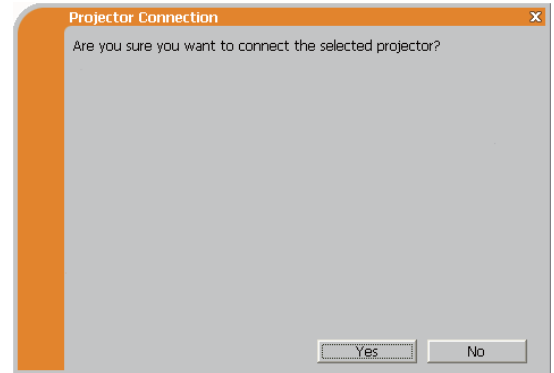

1.5 Selecting the network connection method

There are some options to connect to the network.

- Enter PassCode
- Configure Manually
- Select From List

Select one of them to meet your requirement.

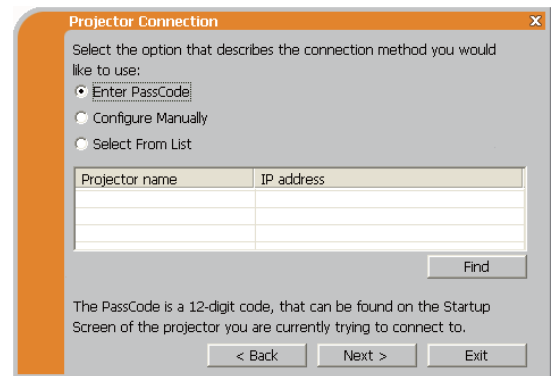

Enter PassCode

If you want to use the Passcode for network connection, select the **[Enter PassCode]** and click the **[Next]**.

The Passcode is given by the projector on screen. And you simply input the Passcode to the “LiveViewer” to connect the network.

Proceed to item **1.5.1 Passcode connection**. (📖15)

Configure Manually

Select the **[Configure Manually]** and click the **[Next]**.

Then, proceed to item **1.6 Manual Configuration**. (📖23)

Select From List

Before selecting this item, your computer and the projectors need to be connected to the same network.

If the connection is already established, select the **[Select From List]**.

From the list of the projectors connected to the network, select which projector you would like to send your images. Proceed to **1.8 Confirming the connection to your destination**. (📖30)

1.5 Selecting the network connection method (continued)

1.5.1 Passcode connection

The unique Passcode system brings you very quick and simple connection to the network.

The Passcode is a code that expresses the network setting in the projector. If you input the code in the “LiveViewer” in your computer, the network setting in the projector and computer can be matched and the connection will be established immediately. The section is intended to explain how to use the Passcode.

(1) Getting the Passcode

The Passcode is 12-digit code consisting of alphanumeric characters (“1-9” and “A-Z”).

Example: PASSCODE 1234-5678-9ABC

The Passcode is given on the projector when the **LAN** port is selected as input source.

NOTE • The Passcode system does not work under the condition below. If such is the case, establish the connection manually.

1) Subnet mask is not Class A or B or C.

The Passcode system accepts Class A, B and C only.

Class A:(255.0.0.0), ClassB:(255.255.0.0), Class C:(255.255.255.0)

There are two methods to get the Passcode from the projector

Method 1

- 1) Turn on the projector, and make sure that the projector image is on screen.
- 2) Press the **COMPUTER** button on the remote control or **INPUT** button on the projector to select the LAN as input port.
If there is no signal on the **LAN** port, you can find the Passcode on screen.

1.5 Selecting the network connection method (continued)

Method 2

- 1) Turn on the projector, and make sure that the projector image is on screen.
- 2) Press the **MENU** button on the remote control or the ▲/▼/◀/▶ buttons on the projector to show the menu on screen.
- 3) Use the ▲/▼ cursor buttons to select the Go to Advanced Menu..., and use the ▶ cursor button to enter the item.
- 4) Use the ▲/▼ cursor buttons to select the NETWORK, and use the ▶ cursor button to enter the item.
- 5) Use the ▲/▼ cursor buttons to select the INFORMATION, and use the ▶ cursor button to display the INFORMATION.
- 6) The Passcode appears in the INFORMATION window.

NOTE • Take the method 2 when you project your computer image by the “LiveViewer”, or when the **LAN** port is not selected as input source.
• If no communication between the projector and computer in 5 minutes, the Passcode will be changed.

1.5 Selecting the network connection method (continued)

(2) Entering the Passcode

If you select **[Enter PassCode]** at item 1.5, the “Please enter the PassCode” screen is displayed. Please enter the Passcode divided 4-digit each in 3 boxes (total 12-digit).

Example PASSCODE: 1234 - 5678 - 9ABC

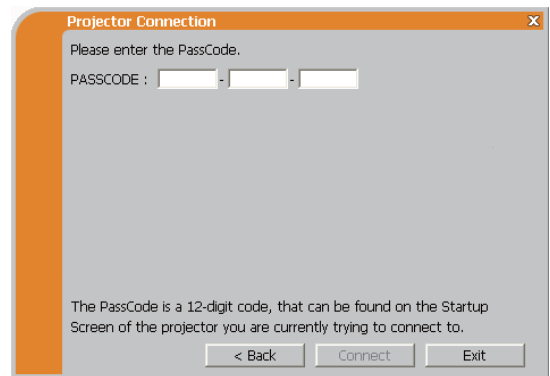

After entering the Passcode, click the **[Connect]** to start the connection to the projector.

Proceed to item **1.8 Confirming the connection to your destination.** (📖30)

If you click the **[Back]**, the screen is back to item **1.5 Selecting the network connection method.** (📖14)

NOTE • When entering the Passcode, capital and small letters are not distinguished.
 • If you are using a Subnet mask other than Class A, B or C, you will have to establish the connection manually.
 If the manual setting screen is displayed, please follow item **1.5.1 (3).** (📖21)

[Troubleshooting]

■ Incorrect PassCode.

The incorrect Passcode was input.

Click the **[Back]** to return to the “Please enter the PassCode” screen.

Check the PassCode on the projector screen (📖15) and enter the code again.

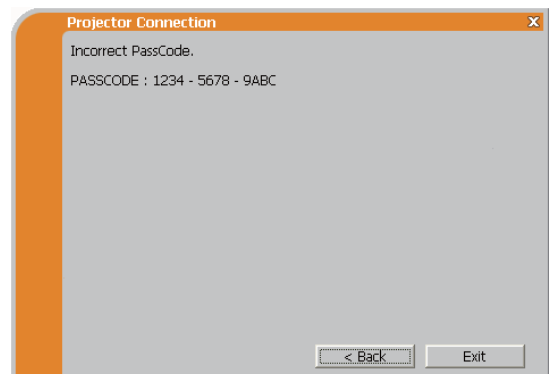



1.5 Selecting the network connection method (continued)

- A network connection could not be established.

Windows prevented network configuration changes.

You may log in the Windows under User authority.



Click the **[OK]**, then the “LiveViewer” main menu is displayed even though the network is not established. Click  on the main and go back to item **1.5 Selecting the network connection method**. (14)

Consult to the network administrator. Log in the Windows under Administrator authority. After that, please resume at item **1.3.2 Starting the “LiveViewer”**. (9)

- If you need to add a Network configuration on your computer to connect to the projector.

This dialog will be displayed when you need to add a Network configuration on your computer to connect to the projector. Confirm with your network administrator if the Network configuration displayed on the dialog is OK, and then click the **[Yes]**.



Click the **[NO]**, then the “LiveViewer” main menu is displayed even though the network is not established. Click  on the main menu and go back to item **1.5 Selecting the network connection method**. (14)

1.5 Selecting the network connection method (continued)

If you put a check mark in the box “Not displaying confirmation dialog for adding Network settings”, the projector memorizes current configuration and this dialog is not displayed again. To display this dialog again, click Option  icon in the “LiveViewer” main menu and remove the check mark in the box “Not displaying confirmation dialog for adding Network settings”.

If you want to change the Network configuration to add, click the **[Change]**. A dialog for changing the Network configuration as shown to the right will be displayed. Enter IP address and subnet mask, then click the **[OK]**. Procedure to connect to the projector will start.

Proceed to item **1.8 Confirming the connection to your destination.** ( 30)

If you click the **[Cancel]**, you will return to the dialog for adding a Network configuration.

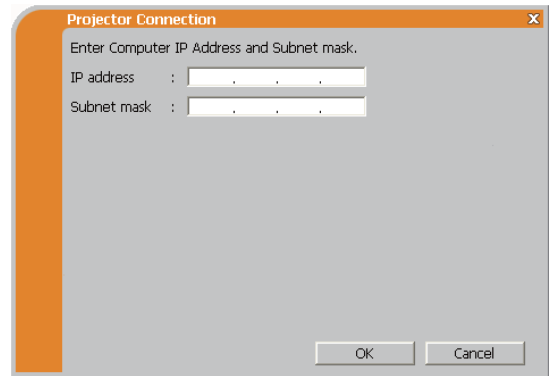

If the entered IP address and projector's IP address are the same, a warning dialog shown to the right will be displayed.

Click the **[OK]**, and then enter a different IP address from the projector's one in the dialog for changing Network configuration.



If the connection is not available with the entered Network configuration, a warning dialog shown to the right will be displayed. Click the **[OK]** to return to the dialog for changing the Network configuration, and then enter appropriate configuration.

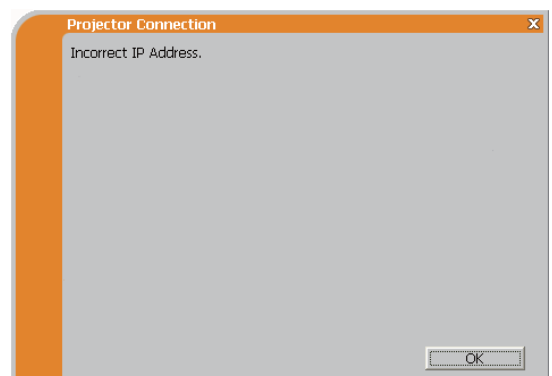

NOTE • If a Network configuration to connect to the projector has been added on the computer, the added Network configuration will be erased once the application software is closed.

1.5 Selecting the network connection method (continued)

■ Are you sure you want to connect the selected projector?

The message is appeared when the wireless adapter you selected is already used for another network connection.

- To connect, click the **[Yes]**. Proceed to item **1.8 Confirming the connection to your destination.** (📖 30)
- Not to connect, click the **[No]** then the “LiveViewer” main menu is displayed even though the network is not established. Click  on the main menu to go back to item **1.5 Selecting the network connection method.** (📖 14)



1.5 Selecting the network connection method (continued)

(3) Configuring manually

After entering the Passcode (📖17), you are required to enter the network configuration manually if you use a Subnet mask other than Class A, B or C. (📖15)
If you use the wired LAN, go to (📖22).

Wireless LAN

The projector is required to be connected to an access point by a LAN cable.

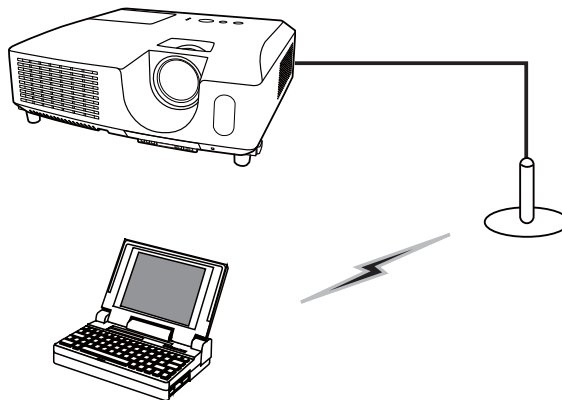

1) The setting on the access point. *1

Enter the following information.

SSID : WirelessAccessPoint (example)

Encryption: WEP64bit (example)

Encryption key *2: ***** (example)

2) The setting on the projector. *3

Enter the following information.

Subnet mask *4: 255.255.255.128
(example)

3) Click the **[Connect]**.

4) The wireless connection will be established.

Proceed to item **1.8 Confirming the connection to your destination.** (📖30)

The screenshot shows a dialog box titled "Projector Connection" with a close button (X) in the top right corner. The dialog contains the following fields and options:

- Enter the following information.
- SSID : [Dropdown menu]
- Encryption : [Dropdown menu showing OFF]
- Encryption key : [Text input field]
- Subnet mask : [Text input field]

Below the input fields, there is a note: "SSID, Encryption and Encryption key: use wireless access point configuration settings. Subnet mask: enter the Subnet mask that the projector is using." At the bottom of the dialog, there are three buttons: "< Back", "Connect", and "Exit".

*1 Contact the network administrator to find out the setting on the access point.

*2 If you use an encryption, you need to set it. Contact the network administrator to check the encryption key that is set in the projector.

The encryption key is always shown as "*****".

*3 To find the network setting on the projector, refer to the NOTE. (📖22)

*4 If you use Subnet mask except Class A/B/C, please set it.

1.5 Selecting the network connection method (continued)

Wired LAN

- 1) Enter the following information for the projector.
Subnet mask *1: 255.255.255.128
(example)
- 2) Click the **[Connect]**.
- 3) The network connection will be established.
Proceed to item **1.8 Confirming the connection to your destination.** (📖30)

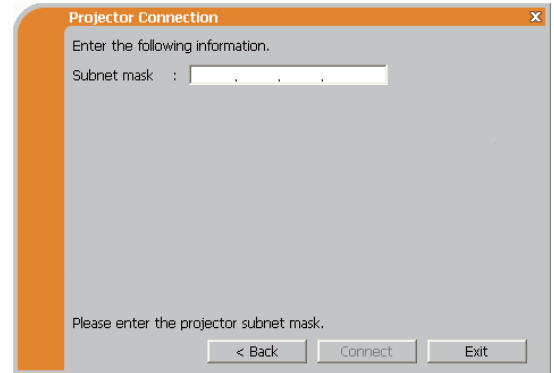

*1 If you use a Subnet mask other than Class A, B or C, this screen appears.

NOTE • If you require the network setting information on the projector, take the following procedure to find it out.

- 1) Turn on the projector, and make sure that the projector image is on screen.
- 2) Press the **MENU** button on the remote control or the ▲/▼/◀/▶ buttons on the projector to show the menu on screen.
- 3) Use the ▲/▼ cursor buttons to select the Go to Advanced Menu..., and use the ▶ cursor button to enter the item.
- 4) Use the ▲/▼ cursor buttons to select the NETWORK, and use the ▶ cursor button to enter the item.
- 5) Use the ▲/▼ cursor buttons to select the INFORMATION, and push the ▶ cursor button.
- 6) The setting will be displayed in the NETWORK_INFORMATION-box.

1.6 Manual configuration

There are 3 options for the manual configuration.

- Profile (📖 below)
- History (📖 24)
- Configure Network Settings Manually (📖 25)

If you select Configure Network Settings Manually, proceed to item **1.7 Configuring the network settings manually.** (📖 25)

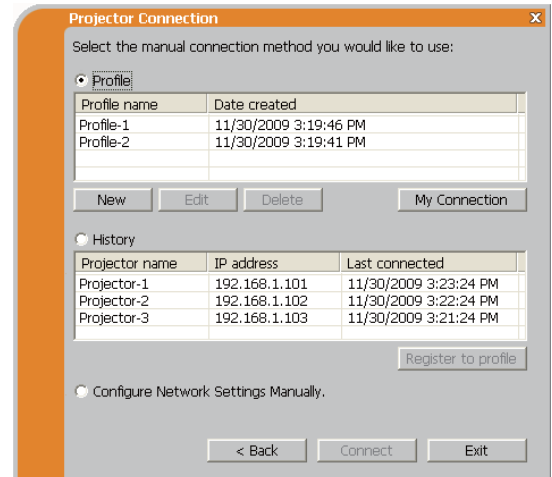

1.6.1 Profile connection

Selecting a profile data connect the network with the projector.

It is required to store the profile data in advance. (📖 33)

- 1) Select the **[Profile]**.
- 2) Choose a profile data listed in the window.
- 3) Click the **[Connect]**.
- 4) The network connection will be established. Proceed to item **1.8 Confirming the connection to your destination.** (📖 30)

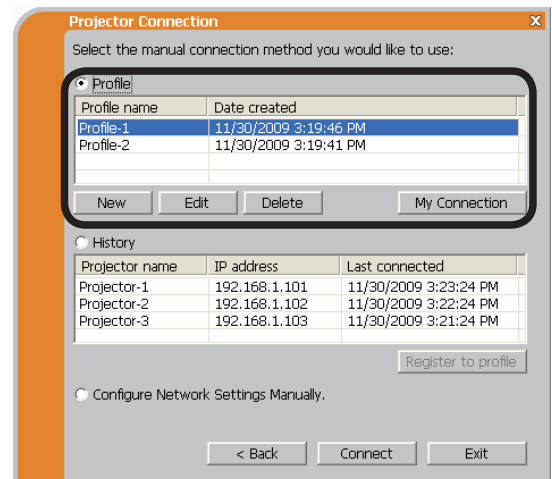

NOTE • To check the setting in a profile data, follow the process below.

- 1) Choose a profile data that you want to check.
- 2) Move the mouse cursor to the profile data, and click the right button on the mouse to display a pop-up menu.
- 3) Select the "Property" in the pop-up menu, and click the left button on the mouse.
- 4) The setting information of the selected profile data is shown.
 - If the DHCP is set on in the projector, the network connection between the projector and computer may not be established since IP address may be varied. If you like to use the Profile connection, set the DHCP off in the projector.

1. Connection to the network

1.6 Manual configuration (continued)

1.6.2 History connection

The “LiveViewer” can memory the network settings when connecting to the projector as a history record. After that, selecting a history record can quickly connect the network with the projector.

- 1) Select the **[History]**.
- 2) Choose a history record listed in the window.
- 3) Click the **[Connect]**.
- 4) The network connection will be established.
Proceed to item **1.8 Confirming the connection to your destination.** (📖 30)

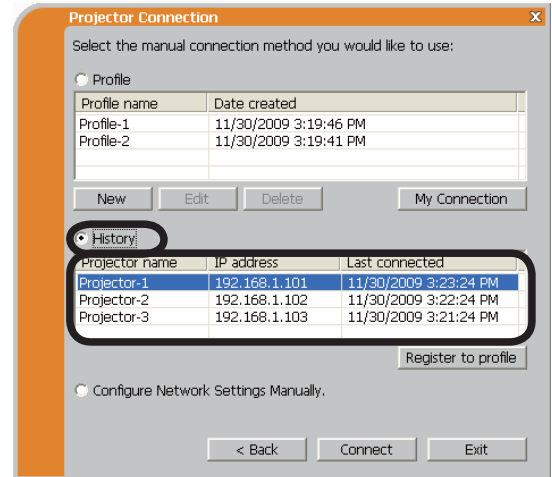

If you want to copy a history record to a profile data, select one of the history record and click the **[Register to profile]**. The profile data cannot be erased automatically.

NOTE • The number of the history record is maximum 10 for each network adapter. When the 11th data is stored, the oldest record among the 10 will be overwritten.

- The data & time information in each history record is renewed when the network is connected by using the history record.
- If the DHCP is set on in the projector, the network connection between the projector and computer may not be established since IP address may be varied.
- Even if you use the profile connection, it will be memorized as a history record.

1.7 Configuring the network settings manually

All setting for the network connection between the projector and computer is input manually.

Select the **[Configure Network Settings Manually]**.

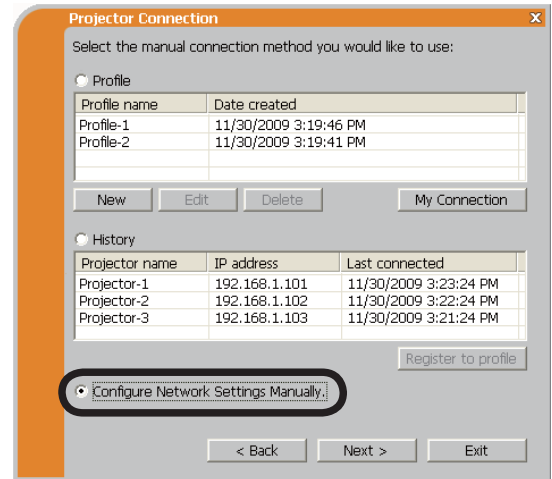

The information to be input manually is different, depending on how you want to connect the projector and computer.

Wireless LAN

The projector is required to be connected to an access point by a LAN cable. Go to (📖26).

Wired LAN

If you use the wired LAN, go to (📖27).

1.7 Configuring the network settings manually (continued)

Wireless LAN

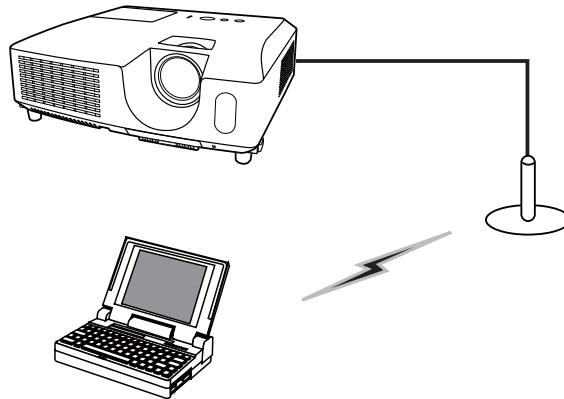

- 1) The setting on the access point. ***1**

Enter the following information.

SSID: WirelessAccessPoint (example)
Encryption: WEP64bit (example)
Encryption key ***2**: ***** (example)
Mode: INFRASTRUCTURE

The screenshot shows the 'Projector Connection' dialog box. It has a title bar with 'Projector Connection' and a close button. The main area contains the text 'Enter the following information.' followed by four fields: 'SSID' (dropdown menu), 'Encryption' (dropdown menu set to 'OFF'), 'Encryption key' (text input field), and 'Mode' (dropdown menu set to 'INFRASTRUCTURE'). Below these fields is the text 'Enter Wireless Access Point Configuration information.' and three buttons: '< Back', 'Next >', and 'Exit'.

- 2) Click the **[Next]**.

- 3) Enter the following information that is set in the projector. ***3**

IP address : 192.168.1.10 (example)
Subnet mask: 255.255.255.0 (example)

The screenshot shows the 'Projector Connection' dialog box. It has a title bar with 'Projector Connection' and a close button. The main area contains the text 'Enter the following information.' followed by two fields: 'IP address' and 'Subnet mask', both with text input fields. Below these fields is the text 'Enter Projector IP Address and Subnet mask.' and three buttons: '< Back', 'Connect', and 'Exit'.

- 4) Click the **[Connect]**.

- 5) The wireless connection will be established.

Proceed to item **1.8 Confirming the connection to your destination.** (📖 30)

- *1** Contact the network administrator to find out the setting on the access point.
***2** If you use an encryption, you need to set it. Contact the network administrator to check the encryption key that is set in the projector.
The encryption key is always shown as “*****”.

- *3** To find the network setting on the projector, refer to the NOTE. (📖 22)

1.7 Configuring the network settings manually (continued)

Wired LAN

- 1) Enter the following information for the projector. ***1**
 IP address : 192.168.1.10 (example)
 Subnet mask : 255.255.255.0 (example)

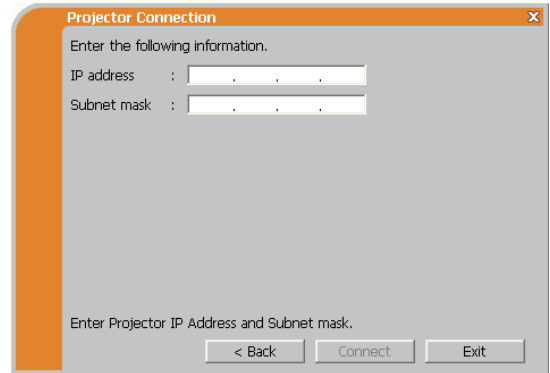

- 2) Click the **[Connect]**.
- 3) The network connection will be established.
 Proceed to item **1.8 Confirming the connection to your destination.** (📖30)

***1** To find the network setting on the projector, refer to the NOTE. (📖22)

[Troubleshooting]

- A network connection could not be established.

Windows prevented network configuration changes.

You may log in the Windows under User authority.

Click the **[OK]**, then the “LiveViewer” main menu is displayed even though the network is not established. Click  on the main menu and go back to item **1.5 Selecting the network connection method.** (📖14)

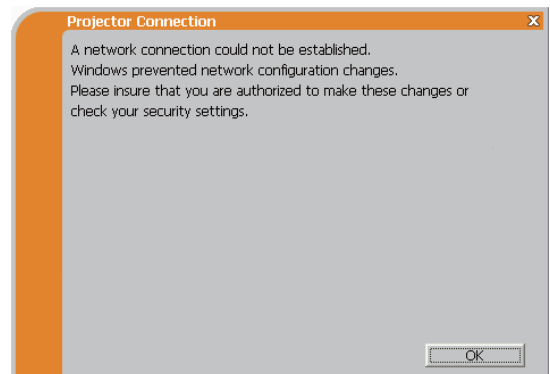



Consult to the network administrator. Log in the Windows under Administrator authority. After that, please resume at item **1.3.2 Starting the “LiveViewer”.** (📖9)

1.7 Configuring the network settings manually (continued)

- If you need to add a Network configuration on your computer to connect to the projector.

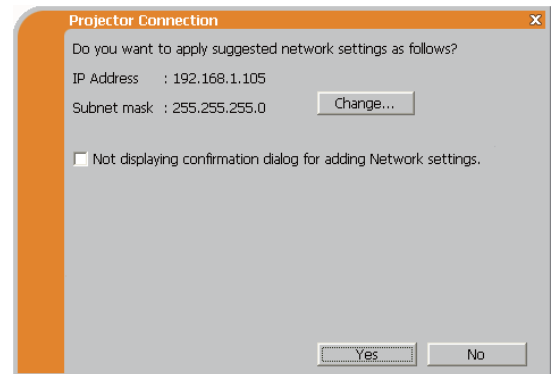
This dialog will be displayed when you need to add a Network configuration on your computer to connect to the projector. Confirm with your network administrator if the Network configuration displayed on the dialog is OK, and then click the **[Yes]**.



Click the **[NO]**, then the “LiveViewer” main menu is displayed even though the network is not established. Click  on the main menu and go back to item **1.5 Selecting the network connection method.** ( 14)

If you put a check mark in the box “Not displaying confirmation dialog for adding Network settings”, the projector memorizes current configuration and this dialog is not displayed again. To display this dialog again, click Option  icon in the “LiveViewer” main menu and remove the check mark in the box “Not displaying confirmation dialog for adding Network settings”.

If you want to change the Network configuration to add, click the **[Change]**. A dialog for changing the Network configuration as shown to the right will be displayed. Enter IP address and subnet mask, then click the **[OK]**. Procedure to connect to the projector will start.

Proceed to item **1.8 Confirming the connection to your destination.** ( 30)

If you click the **[Cancel]**, you will return to the dialog for adding a Network configuration.

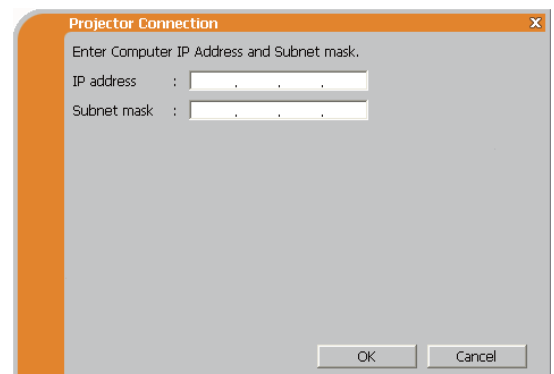

1.7 Configuring the network settings manually (continued)

If the entered IP address and projector's IP address are the same, a warning dialog shown to the right will be displayed.

Click the **[OK]**, and then enter a different IP address from the projector's one in the dialog for changing Network configuration.



If the connection is not available with the entered Network configuration, a warning dialog shown to the right will be displayed. Click the **[OK]** to return to the dialog for changing the Network configuration, and then enter appropriate configuration.

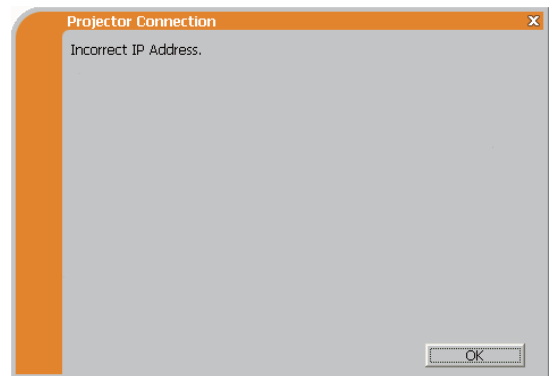

NOTE • If a Network configuration to connect to the projector has been added on the computer, the added Network configuration will be erased once the application software is closed.

■ Are you sure you want to connect the selected projector?

The message is appeared when the wireless adapter you selected is already used for another network connection.

- To connect, click the **[Yes]**. Proceed to item **1.8 Confirming the connection to your destination.** (📖 30)
- Not to connect, click the **[No]** then the “LiveViewer” main menu is displayed even though the network is not established. Click  on the main menu to go back to item **1.5 Selecting the network connection method.** (📖 14)

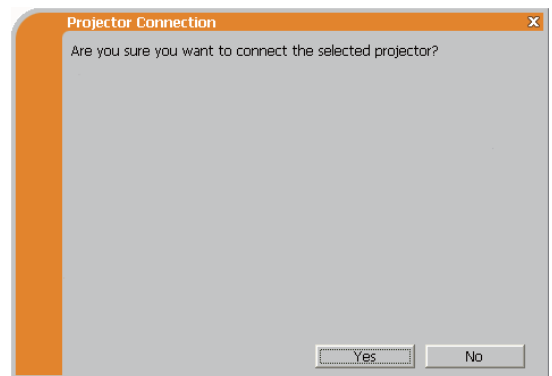



1.8 Confirming the connection to your destination

1.8.1 Connection and transmission

When the network connection is established, the “Connection to Projector successful” screen is displayed.

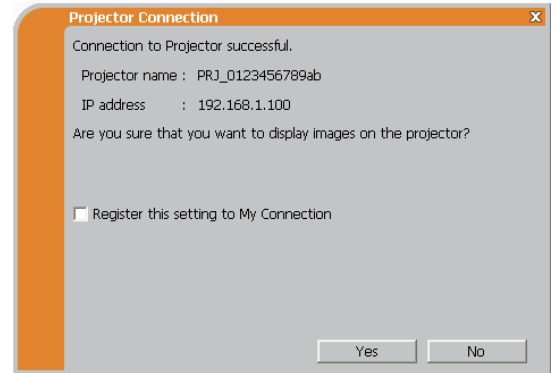
Make sure that the right projector that you want to send your image to is selected, by checking the projector name and IP address shown in the screen.



- To send images to the projector, click the **[Yes]**. The transmission will be started. To display the transmitted images, select the **LAN** port as input source on the projector.
- Not to send, click the **[No]**, then the “LiveViewer” main menu is displayed in stand-by mode. (The stand-by mode is the condition that the wireless connection is established, but the images are not transmitted.) The transmission can be started, if you click  or  button on the “LiveViewer” main menu.

If you wish to use the current connection setting as a profile data for My Connection, check in the box for the **[Register this setting to My Connection]**.

[Troubleshooting]

- This projector is currently in use (Presenting) by another user.

The projector you want to send your images to is occupied by another computer in the Presenter mode.

Click the **[OK]**, then the “LiveViewer” main menu is displayed in stand-by mode. Retry to send your images, after the Presenter mode is off.

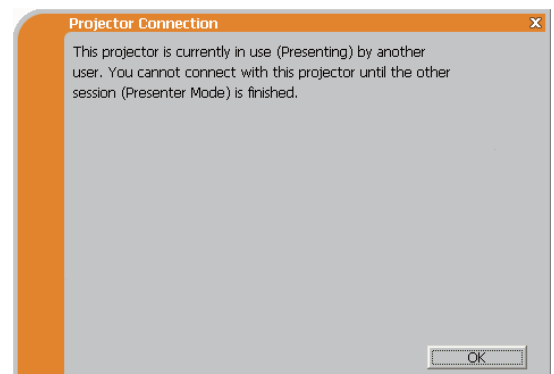

1.8 Confirming the connection to your destination (continued)

- A Slideshow is currently running on the projector that you are trying to display to.

The projector you want to send your images to is in the Slideshow mode in the PC-LESS Presentation.

- Click the **[Yes]**, then the projector will stop the Slideshow and switch the input source to the **LAN** port.
- Click the **[No]**, then the projector is remained in the Slideshow mode, and the “LiveViewer” main menu is displayed in stand-by mode on your computer.

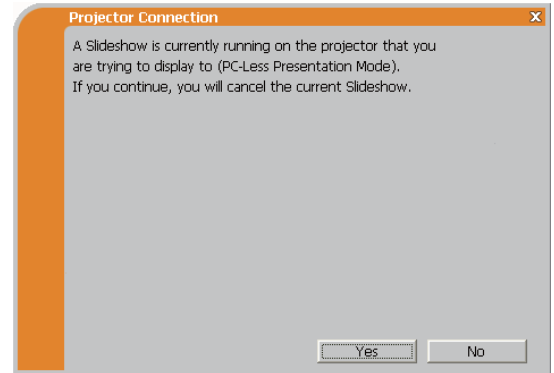

- Are you sure you want to change the input channel of the Projector to LAN?

The projector is not set to the LAN as an input signal.

- Click the **[Yes]**, then the projector is switched to the LAN.
- Click the **[No]**, then the projector is remained as it is, and the “LiveViewer” main menu is displayed in stand-by mode on your computer.

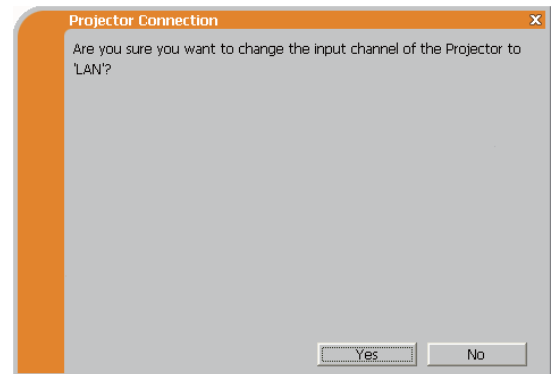



1. Connection to the network

1.8 Confirming the connection to your destination (continued)

1.8.2 Connection error

When the connection to the projector could not be established, an error message, “Network Connection not established”, will come up.

Click the **[OK]** then the “LiveViewer” main menu is displayed even though the network is not established. Click  on the main menu to go back to item **1.5 Selecting the network connection method.** (14)

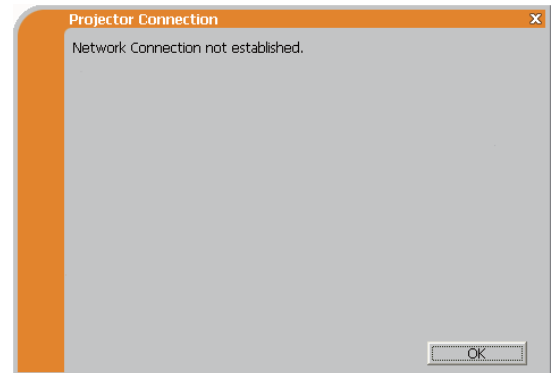

NOTE • If you selected the My Connection, the “LiveViewer” is closed. Check the network setting in the projector, and retry the connection from item **1.3.2 Starting the “LiveViewer”.** (9)

1.9 Profile data

1.9.1 Outline of Profile data

The network setting to connect the projector and computer can be stored as a profile data. Once the data is stored, all you need to do is to select the data to connect to the network. It is recommended when the same network connection is often used.

1.9.2 Making Profile data

The profile data is made on the Manual Configuration screen. (📖23)

Up to 10 profile data can be stored for each network adapter.

1) Select the **[Profile]** and click the **[New]**.

2) The “Create new profile” will come up.
If you have already made 10 profile data, you cannot make a new one, until you delete a stored data.

Input all information required for your network connection.

If you want to clear the information you input, click the **[Clear]**.

3) Click the **[OK]**, after all information is set.
If you don't want to store it, click the **[Cancel]**.

4) The new profile data is shown in the profile list, if you click the **[OK]**.

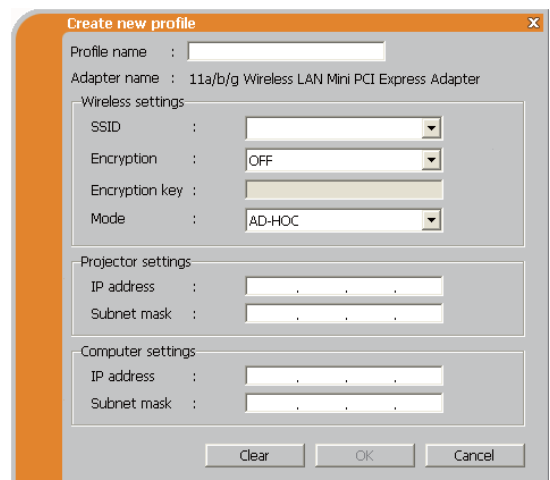
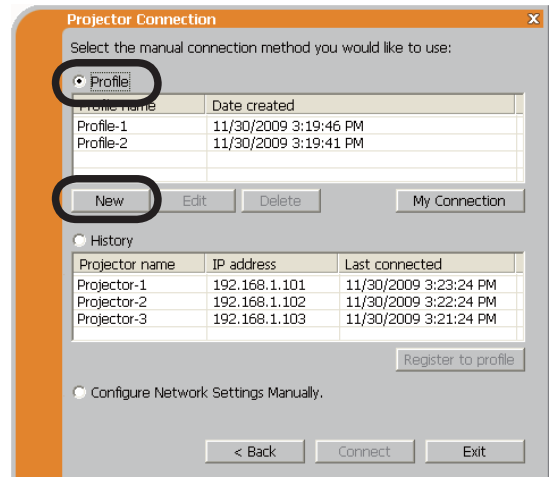

NOTE • When you make a new profile data, it is strongly recommended to check that the new data can work properly by selecting the data at the Profile connection. (📖23)

• If you change a wireless network adapter on your computer, make a new profile data for the adapter.

1. Connection to the network

1.9 Profile data (continued)

1.9.3 Editing Profile data

If necessary, the profile data can be edited on the Manual Configuration screen. (📖 23)

- 1) Select the **[Profile]**, and select one of the data listed in the window.
- 2) Click the **[Edit]**.
- 3) The “Edit profile” screen will come up.
- 4) Edit the information required to be revised. If you want to clear all information in the window, click the **[Clear]**.
- 5) Click the **[OK]**, after the editing is completed. If you don't want to store it, click the **[Cancel]**.
- 6) The edited profile data is stored and shown in the profile list with the new date created information, if you click the **[OK]**.

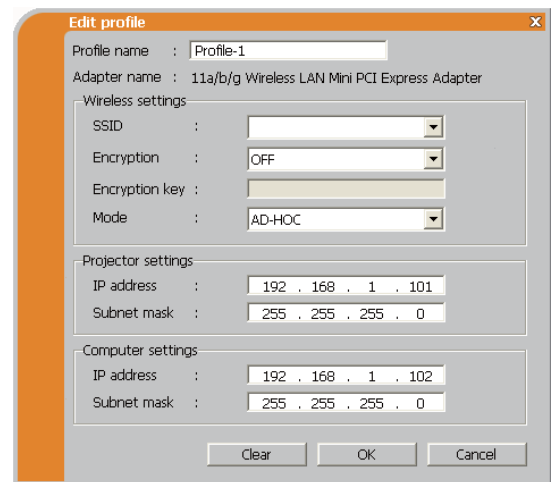
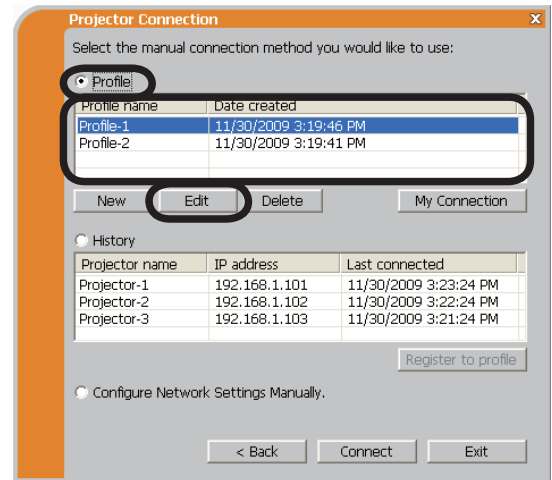

NOTE • When you edit a profile data, it is strongly recommended to check that the edited data can work properly by selecting the data at the Profile connection. (📖 23)

1.9 Profile data (continued)

1.9.4 Registering My Connection

One of the profile data, which is often used, can be registered as the My Connection profile data. Once the data is registered, all you need to do is to select the My Connection to connect to the network. (📖12)

- 1) Click the **[My Connection]**.
- 2) The “Add My Connection” screen will come up.
The currently selected profile data for the My Connection is shown with a check mark in the list.
- 3) Select one of the profile data listed in the window and put a mark in the check box.
The data selected before is turned unmarked.
- 4) Click the **[OK]**, then the window is closed.
If you don't want to select a new one, click the **[Cancel]**.

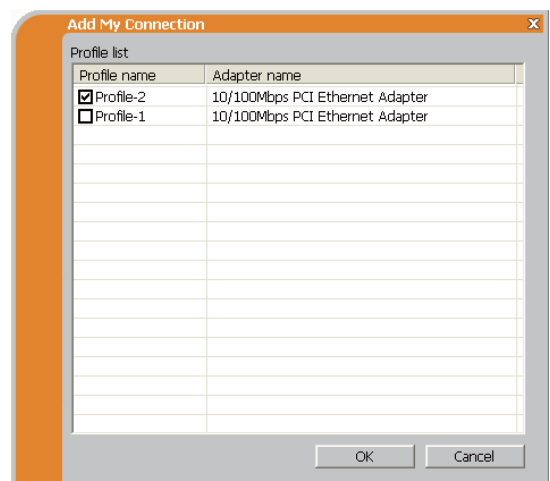
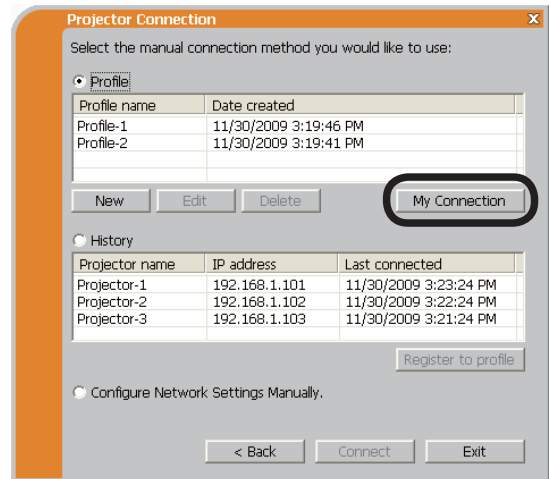

NOTE • If you don't want to use the My Connection, mark no data listed in the window, and click the **[OK]**.

- In the list, all profile data are shown no matter which network adapter is selected. You can register a profile data that is not for currently selected network adapter as the My Connection profile data.

1. Connection to the network

1.9 Profile data (continued)

Also, you can register a profile data to My Connection, when the network connection is established. When it is established, the “Connection to Projector successful” screen is displayed. (📖 30)

If you wish to use the current connection setting for My Connection, check in the box for the **[Register this setting to My Connection]**. And then, if it is okay to overwrite the present data for My Connection, click the **[OK]**.

A new profile data will be created and it is registered as My Connection profile data.

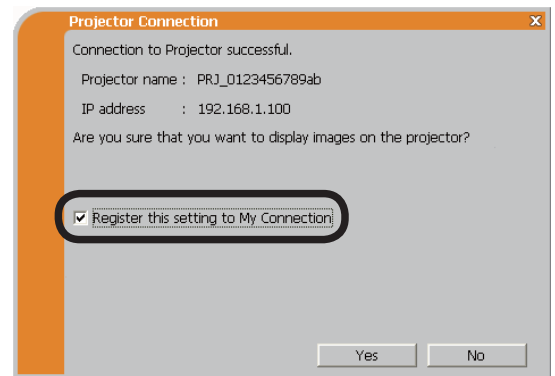

- NOTE** • If there are already 10 profile data, the check box cannot be checked. Please erase one of the existing profile data.
- The profile name for the stored data is assigned by the “LiveViewer” automatically. The name will be shown at the right side of the check box.

2. Network Presentation

2.1 Using the “LiveViewer”

When you get the connection between your projector and computer, the “LiveViewer” main menu will be shown on the computer screen.

On the main menu you can configure settings and operate functions to send your images to the projector.

2.1.1 Main menu and Operating buttons

1) Menu Type

There are 2 type of the main menu, Easy type and Advanced type, which can be switched on screen.

- When the “LiveViewer” is started, the last used type will be on screen.
- When the network connection is not established, the Advanced type will be on screen.

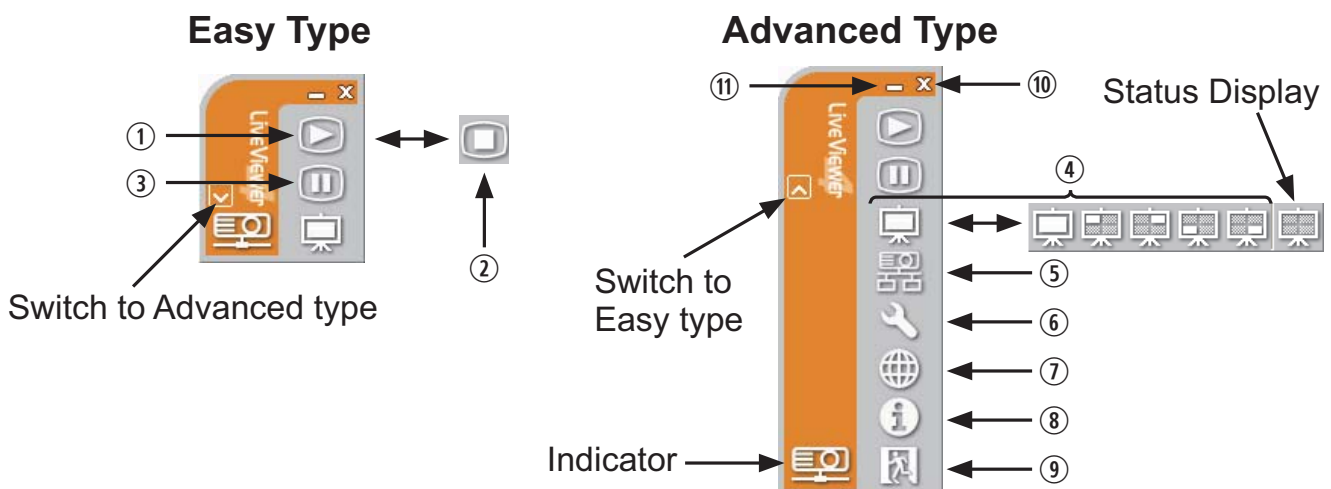

2) Operating buttons

① Starting Capture button

The transmission to the projector is started and the images will be displayed. The Display mode will be the Single PC mode at first. After that, the last Display mode will be applied.

② Stop button

The image transmission is stopped.

NOTE • The images may not be displayed on screen, if the Start/Stop buttons are clicked repeatedly.

• The primary image is displayed in multi-display environment.

2.1 Using the “LiveViewer” (continued)

③ **Hold button**

The image on screen is temporally frozen.

The last image before the button is clicked is remained on screen.

You can revise the image data on your computer without showing it on the projector’s screen.

④ **Display mode button** (📖40)

The button switches the Single PC mode and Multi PC mode.

⑤ **Connect button**

The screen to select the connection mode is displayed.

Go to item 1.5. (📖14)

⑥ **Option button**

The option screen is displayed.

⑦ **Web control button**

Starts the Web browser on your computer and displays Web control screen to control the projector and change various settings for the projector. (📖45)

⑧ **Information button**

The version of the “LiveViewer” is displayed.

⑨, ⑩ **Close button**

The network is disconnected and the “LiveViewer” is closed.

⑪ **Minimize button**

The main menu is closed, and the “LiveViewer” icon is displayed on the task tray in your computer. The displayed icon changes as shown below depending on the status of the “LiveViewer”. If the icon is double-clicked, the last type of the main menu will be shown on screen.

Connected

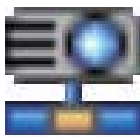

Disconnected



Not connected

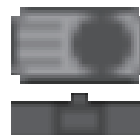

Hold

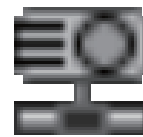





2.1 Using the “LiveViewer” (continued)

2.1.2 Displaying the status

1) Indicator

















The indicator shows the following status.

Indicator	Status	Note
	Not connected	The network connection to the projector is not established yet.
	Hold	The network connection is established, but the image transmissions on hold.
	Connected	The network connection is established and the images on the computer are being sent to the projector.
	Disconnected	The network connection to the projector is disconnected.

2) Status Display in Multi PC mode

The icon is displayed at the right end of the Display mode buttons.

One of the following icons to inform which quarter screens are used will be shown.

Status	Status icon
No computer is on screen	
One computer is on screen.	   
Two computers are on screen.	     
Three computers are on screen.	   
Four computers are on screen.	

NOTE • The status display is refreshed in every 3 seconds.
 • If the status cannot be gotten from the projector, it will not be displayed.

2. Network Presentation

2.1 Using the “LiveViewer” (continued)

2.1.3 Switching the display mode

The “LiveViewer” has the Single PC mode and Multi PC mode. The modes can be switched on the main menu.

- 1) Click the  button on the main menu.
The buttons below are displayed.

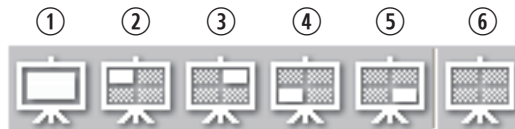

⑥: Status Display

- 2) Select from ① to ⑤ buttons, and click it.
 - ① Switching to the Single PC mode : Your image is displayed on full screen.
 - ②-⑤ Switching to the Multi PC mode : Your image is displayed on a quarter screen identified in the button.
- 3) The projector screen is switched to the mode selected above, and the transmission of your computer image will be started to display your image on the screen.
- 4) The icon  on the main menu is replaced by the icon you selected.

NOTE • The image transmission will be stopped, when you click the Single mode button while the projector is in the Single PC mode or you click one of the Multi mode buttons that shows the quarter screen which is currently displaying your computer images in the Multi PC mode.

- If the Multi PC mode is selected, the projector screen is automatically divided to 4 zones.
- If the Presenter mode is set on in the computer whose image is currently on screen in the Single PC mode, the  button cannot be clicked on other computers.
- If you select one of the quarter screen buttons that indicates images sent from another computer, the transmission of your computer image will be stopped.

The display mode can be set also by using the MULTI PC MODE in the PRESENTATION item in the NETWORK menu. The last setting will be active. (Refer to [NETWORK menu in the User's Manual – Operating Guide](#) for the function on the projector.)

2.1 Using the “LiveViewer” (continued)

2.1.4 Option menu

Clicking the Option button displays the option menu on screen.

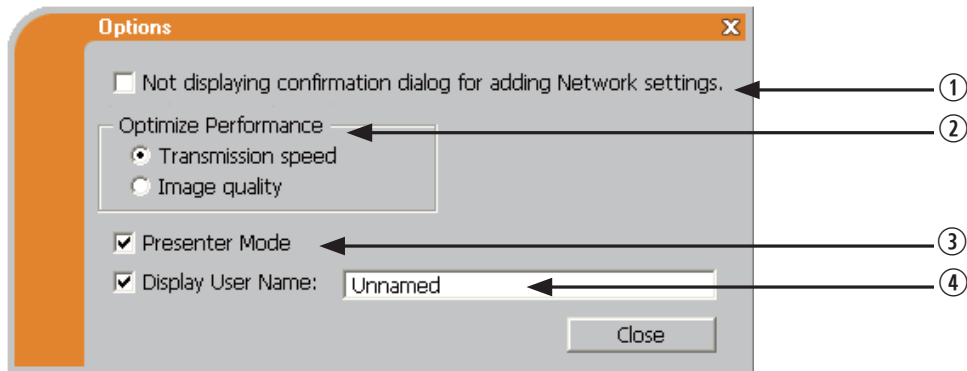

① “Not displaying confirmation dialog for adding Network settings”

This setting allows you to choose to display or not the confirmation dialog for adding a Network configuration (📖 19, 28) when you connect your computer to the projector. It is turned off by default.

② Optimize Performance

The “LiveViewer” captures computer screen in JPEG data and sends the JPEG data to the projector. The “LiveViewer” has two options that have different compression rate of JPEG data.

Transmission speed

Speed takes priority over Image quality.
It makes JPEG compression rate higher.

The screen on the projector is rewritten quicker because the transferred data is smaller, but the image quality is worse.

Image quality

Image quality takes priority over Speed.
It makes JPEG compression rate lower.

The screen on the projector is rewritten slower because the transferred data is larger, but the image quality is better.

2.1 Using the “LiveViewer” (continued)

③ Presenter Mode

In the Single PC mode, the projector can be occupied by one computer and can block an access from any other computer, if the Presenter mode is selected in the “LiveViewer”.

While making your presentation, you don't need to worry that the image on screen is unexpectedly switched to an image sent by another computer. If you want to turn it on, put a check mark in the check box.

NOTE • If the Multi PC mode is selected, the setting for the Presenter mode is invalid.

- When switching from the Multi PC mode to the Single PC mode, the Presenter mode setting of the computer is valid.
- The Presenter Mode is set valid in factory default setting.
- In addition to using the software menu on the computer on which Presenter Mode is turned on, you can cancel this function by using the projector's OSD menu QUIT PRESENTER MODE EXECUTE of the PRESENTATION item in the NETWORK menu.

④ Display User Name

A “User Name” that is up to 20 letters can be input by using alphanumeric characters.

The user name can be displayed on the projector screen, so you can find out whose image is currently on the screen.

(Refer to  **NETWORK menu in the User's Manual – Operating Guide**)

If the check box is not marked, the information is not sent to the projector.

2.2 Starting the Network Presentation

This chapter explains the Network Presentation feature with which you can project computer images transmitted through a network.

The “LiveViewer” allows you to project images from one or multiple computers by connecting the projector to an existing network without using computer cables. This Network Presentation feature helps you to smoothly make your presentations and conduct conferences.

To start the Network Presentation, select the **LAN** port as the input source on the projector and click the Starting Capture button on the “LiveViewer”.

2.2.1 Display mode

Two display modes, Single PC mode and Multi PC mode, are available for the Network Presentation.

1) Single PC mode

The projector displays images sent by one computer.

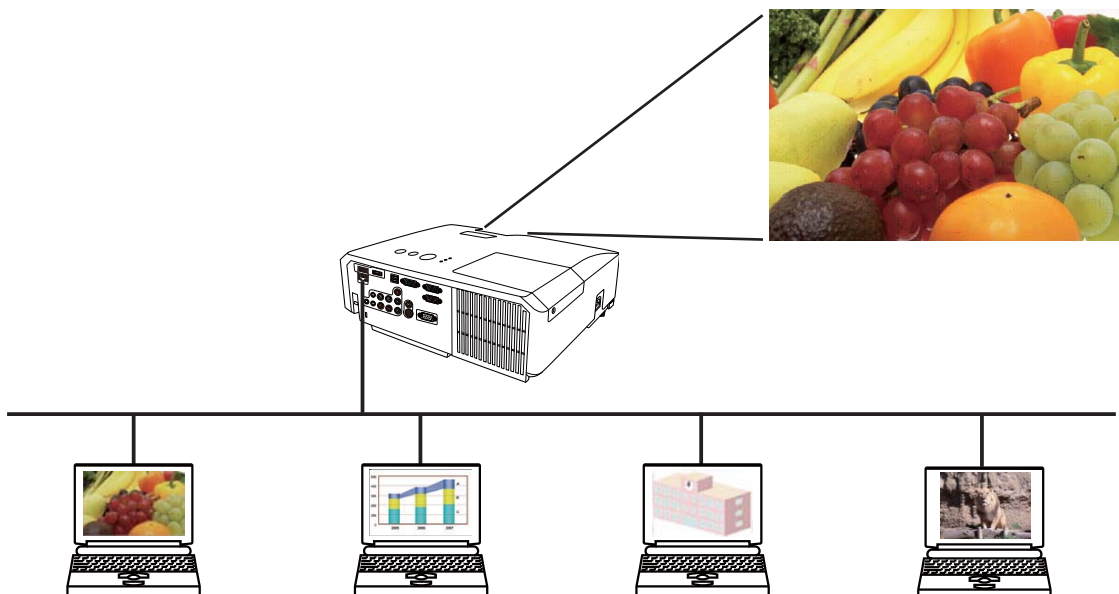

2.2 Starting the Network Presentation (continued)

2) Multi PC mode

The projector screen is divided to 4 zones. The projector displays images in one zone sent by a computer, so that the projector can display images sent by up to 4 computers at the same time.

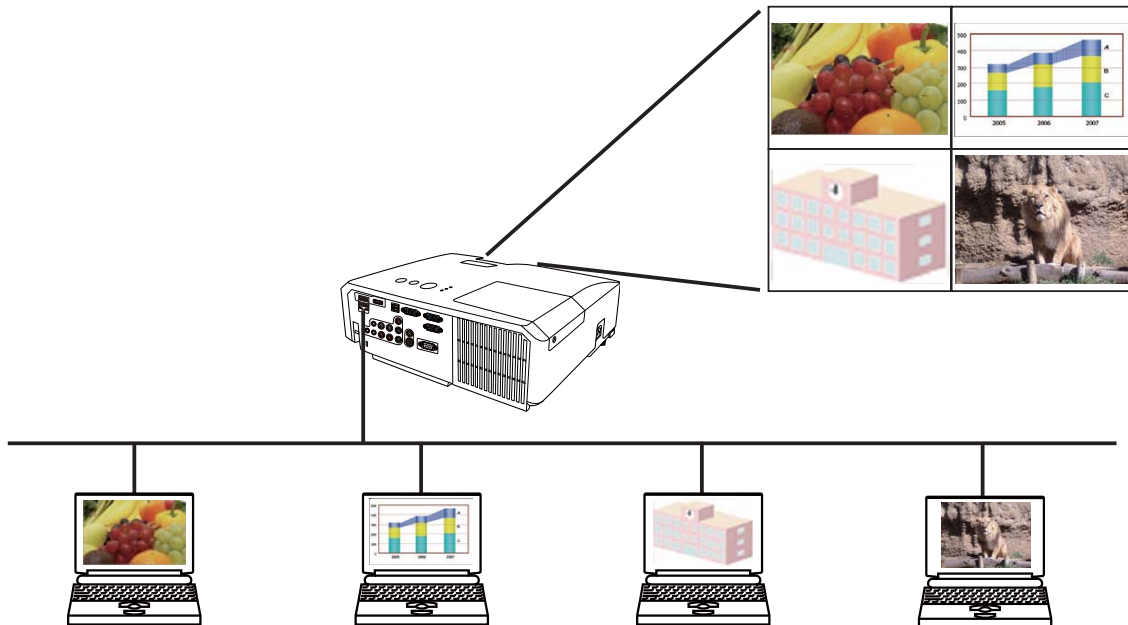

2.2.2 Presenter mode

In the Single PC mode, the projector can be occupied by one computer and can block an access from any other computer, if the Presenter mode is selected in the “LiveViewer”.

While making your presentation, you don’t need to worry that the image on screen is unexpectedly switched to an image sent by another computer.

The Presenter mode can be set on the Option menu in the “LiveViewer” main menu. (📖41)

2.2.3 Display User Name

A “User Name” can be input in the “LiveViewer”, which is displayed on screen by operating the menu on the projector. So, it can be found out whose image is currently displayed on screen. (📖41)

3. Web Control

You can adjust or control the projector via a network from a web browser on a computer that is connected to the same network.

- NOTE** • Internet Explorer 6.0 or later is required.
- If JavaScript is disabled in your web browser configuration, you must enable JavaScript in order to use the projector web pages properly. See the Help files for your web browser for details on how to enable JavaScript.
 - It is recommended that all web browser updates are installed.

3.1 Logon

To use the Web Control function, you need to logon with your user name and password. (📖47)

Refer to the following for configuring or controlling the projector via a web browser.

Example: If the IP address of the projector is set to **192.168.1.10**:

1) Display the logon window as shown on the right. There are two options to display this window.

① Using the “LiveViewer”

Connect your computer and the projector via Network using the “LiveViewer”. (📖9) Then click the Web Control button 🌐 on the “LiveViewer” main menu (📖37) to start the Web browser software.

② Using Web browser software

Make sure that your computer and the projector is connected via network, and then start Web browser.

Enter the projector's IP address into URL input box of the Web browser as the example below, and then press the Enter key or → button.

Example: If the IP address of the projector is set to **192.168.1.10**:

Enter “**http://192.168.1.10/**” into the address bar of the web browser and press the Enter key or click → button.



2) Enter your user name and password, and then click the [OK].

NOTE • The language used on the Web Control screen is the same as that of the OSD on the projector. If you want to change it, you need to change the OSD language on the projector. (📖**SCREEN menu in the User’s Manual – Operating Guide**)

3.1 Logon (Continued)

Below are the factory default settings for user name and password.

User name	Password
Administrator	<blank>

If you logon successfully, the screen below will be displayed.

Main menu

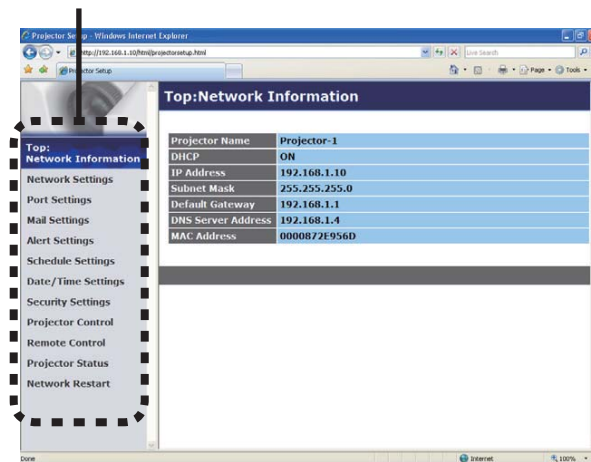

3) Click the desired operation or configuration item on the main menu.

3.2 Network Information

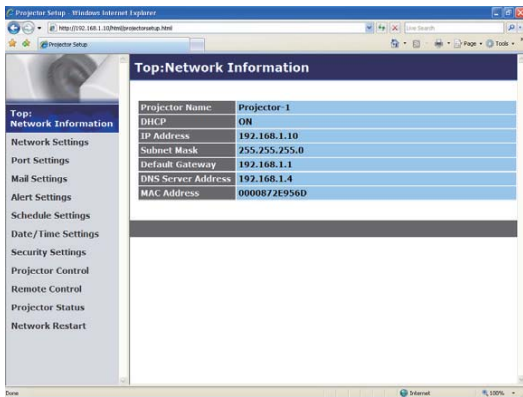

Displays the projector's current network configuration settings.

Item	Description
Projector Name	Displays the projector name settings.
DHCP	Displays the DHCP configuration settings.
IP Address	Displays the current IP address.
Subnet Mask	Displays the subnet mask.
Default Gateway	Displays the default gateway.
DNS Server Address	Displays the DNS server address.
MAC Address	Displays the ethernet MAC address.

3.3 Network Settings

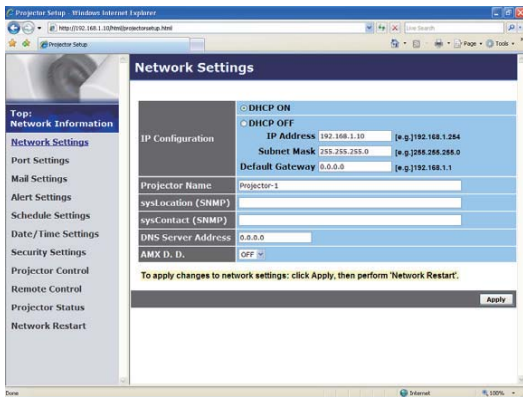

Displays and configures network settings.

Item	Description
IP Configuration	Configures network settings.
DHCP ON	Enables DHCP.
DHCP OFF	Disables DHCP.
IP Address	Configures the IP address when DHCP is disabled.
Subnet Mask	Configures the subnet mask when DHCP is disabled.
Default Gateway	Configures the default gateway when DHCP is disabled.
Projector Name	Configures the name of the projector. The length of the Projector Name can be up to 64 alphanumeric characters. Only alphabets, numbers and following symbols can be used. !"#%&'()*+,-./:;<=>?@[\\]^_`{ }~ and space. Particular projector name is pre-assigned by default.
sysLocation (SNMP)	Configures the location to be referred to when using SNMP. The length of the sysLocation can be up to 255 alphanumeric characters. Only numbers '0-9' and alphabet 'a-z', 'A-Z' can be used.
sysContact (SNMP)	Configures the contact information to be referred to when using SNMP. The length of the sysContact can be up to 255 alphanumeric characters. Only numbers '0-9' and alphabet 'a-z', 'A-Z' can be used.
DNS Server Address	Configures the DNS server address.
AMX D.D. (AMX Device Discovery)	Configures the AMX Device Discovery setting to detect the projector from the controllers of AMX connected to the same network. For the details of AMX Device Discovery, visit the AMX web site. URL: http://www.amx.com

Click the **[Apply]** button to save the settings.

NOTE • The new configuration settings are activated after restarting the network connection. When the configuration settings are changed, you must restart the network connection. You can restart the network connection by clicking the **[Network Restart]** on the main menu.

- If you connect the projector to an existing network, consult a network administrator before setting server addresses.

3.4 Port Settings

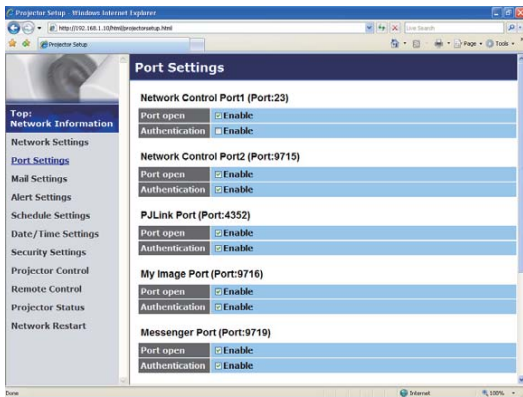

Displays and configures communication port settings.

Item	Description
Network Control Port1 (Port:23)	Configures command control port 1 (Port:23).
Port open	Click the [Enable] check box to use port 23.
Authentification	Click the [Enable] check box when authentication is required for this port.
Network Control Port2 (Port:9715)	Configures command control port 2 (Port:9715).
Port open	Click the [Enable] check box to use port 9715.
Authentification	Click the [Enable] check box when authentication is required for this port.
PJLink™ Port (Port:4352)	Configures the PJLink™ port (Port:4352).
Port open	Click the [Enable] check box to use port 4352.
Authentification	Click the [Enable] check box when authentication is required for this port.
My Image Port (Port:9716)	Configures the My Image Port (Port:9716).
Port open	Click the [Enable] check box to use port 9716.
Authentification	Click the [Enable] check box when authentication is required for this port.
Messenger Port (Port:9719)	Configures the Messenger Port (Port:9719).
Port open	Click the [Enable] check box to use port 9719.
Authentification	Click the [Enable] check box when authentication is required for this port.

3.4 Port Settings (Continued)

Item	Description
SNMP Port	Configures the SNMP port.
Port open	Click the [Enable] check box to use SNMP.
Trap address	Configures the destination of the SNMP Trap in IP format. • The address allows not only IP address but also domain name if the valid DNS server is setup in the Network Settings . The maximum length of host or domain name is up to 255 characters.
Download MIB file	Downloads a MIB file from the projector.
Network Bridge Port	Configures the Bridge port number.
Port Number	Input the port number. Except for 9715, 9716, 9719, 9720, 5900, 5500, 4352 between 1024 and 65535 can be set up. It is set to 9717 as the default setting.

Click the **[Apply]** button to save the settings.

NOTE • The new configuration settings are activated after restarting the network connection. When the configuration settings are changed, you must restart the network connection. You can restart the network connection by clicking the **[Network Restart]** on the main menu.

3.5 Mail Settings

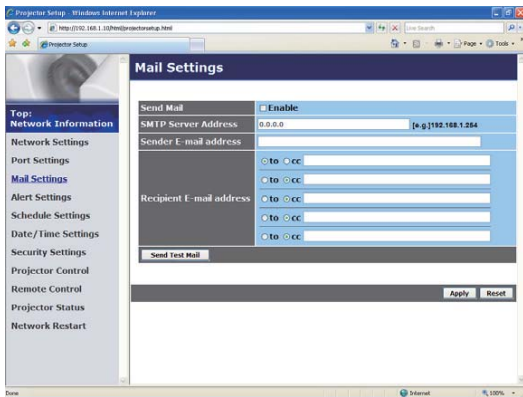

Displays and configures e-mail addressing settings.

Item	Description
Send Mail	Click the [Enable] check box to use the e-mail function. Configure the conditions for sending e-mail under the Alert Settings.
SMTP Server Address	Configures the address of the mail server in IP format. <ul style="list-style-type: none"> The address allows not only IP address but also domain name if the valid DNS server is setup in the Network Settings. The maximum length of host or domain name is up to 255 characters.
Sender E-mail address	Configures the sender e-mail address. The length of the sender e-mail address can be up to 255 alphanumeric characters.
Recipient E-mail address	Configures the e-mail address of up to five recipients. You can also specify the [TO] or [CC] for each address. The length of the recipient e-mail address can be up to 255 alphanumeric characters.

Click the **[Apply]** button to save the settings.

NOTE • You can confirm whether the mail settings work correctly using the **[Send Test Mail]** button. Please enable Send mail setting before clicking the **[Send Test Mail]**.

- If you connect the projector to an existing network, consult a network administrator before setting server addresses.

3.6 Alert Settings

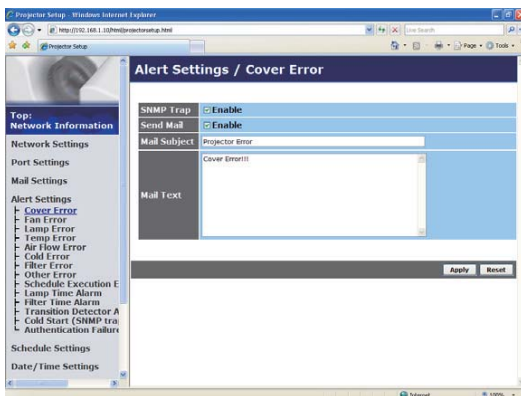

Displays and configures failure & alert settings.

Item	Description
Cover Error	The lamp cover has not been properly fixed.
Fan Error	The cooling fan is not operating.
Lamp Error	The lamp does not light, and there is a possibility that interior portion has become heated.
Temp Error	There is a possibility that the interior portion has become heated.
Air Flow Error	The internal temperature is rising.
Cold Error	There is a possibility that the interior portion has become overcooled.
Filter Error	Filter time over.
Other Error	Other error. If displaying this error, please contact your dealer.
Schedule Execution Error	Schedule Execution error. (📖55)
Lamp Time Alarm	Lamp time over Alarm Time setting.
Filter Time Alarm	Filter time over Alarm Time setting.
Transition Detector Alarm	Transition Detector Alarm. (📖 OPTION menu in the User's Manual – Operating Guide)
Cold Start	When the projector is supplied with the power, it works as below. <ul style="list-style-type: none"> • If the STANDBY MODE is set to the NORMAL:the projector's power status changes from "OFF" to "Standby state". • If the STANDBY MODE is set to the SAVING:the projector's power status changes from "Standby state" to "ON (lamp is turned on)". (📖 SETUP menu in the User's Manual – Operating Guide)
Authentication Failure	The SNMP access is detected from the invalid SNMP community.

Refer to 📖 **"Troubleshooting" in the User's Manual – Operating Guide** for further detailed explanation of Error except Other Error and Schedule Execution Error.

3.6 Alert Settings (Continued)

The Alert Items are shown below.

Item	Description
Alarm Time	Configures the time to alert. (Only Lamp Time Alarm and Filter Time Alarm .)
SNMP Trap	Click the [Enable] check box to enable SNMP Trap alerts.
Send Mail	Click the [Enable] check box to enable e-mail alerts. (Except Cold Start and Authentication Failure .)
Mail Subject	Configures the subject line of the e-mail to be sent. The length of the subject line can be up to 100 alphanumeric characters. (Except Cold Start and Authentication Failure .)
Mail Text	Configures the text of the e-mail to be sent. The length of the text can be up to 1024 alphanumeric characters, but if you are using some of special characters below the length may be shorter. Special characters " ' : & , % \ and space (Except Cold Start and Authentication Failure .)

Click the **[Apply]** button to save the settings.

NOTE • The trigger of **Filter Error** e-mail is depending on the FILTER MESSAGE setting in the SERVICE item of the OPTION menu which defines the period until the filter message is displayed on the projector screen. The e-mail will be sent when the filter timer exceeds 100, 200, 500, 1000, 2000 or 5000 hours based on the configuration. No notification e-mail will be sent if the FILTER MESSAGE is set to TURN OFF. ( **OPTION menu in the User's Manual – Operating Guide**)

- **Lamp Time Alarm** is defined as a threshold for e-mail notification (reminder) of the lamp timer. When the lamp hour exceeds this threshold that is configured through the Web page, the e-mail will be sent out.
- **Filter Time Alarm** is defined as a threshold for e-mail notification (reminder) of the filter time. When the filter hour exceeds this threshold that is configured in the Web page, the e-mail will be sent out.

3.7 Schedule Settings

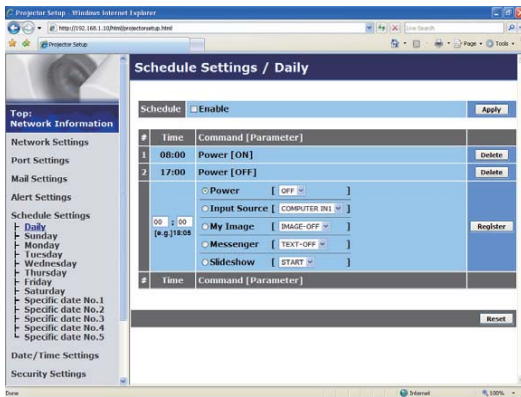

Displays and configures schedule settings.

Item	Description
Daily	Configures the daily schedule.
Sunday	Configures the Sunday schedule.
Monday	Configures the Monday schedule.
Tuesday	Configures the Tuesday schedule.
Wednesday	Configures the Wednesday schedule.
Thursday	Configures the Thursday schedule.
Friday	Configures the Friday schedule.
Saturday	Configures the Saturday schedule.
Specific date No.1	Configures the specific date (No.1) schedule.
Specific date No.2	Configures the specific date (No.2) schedule.
Specific date No.3	Configures the specific date (No.3) schedule.
Specific date No.4	Configures the specific date (No.4) schedule.
Specific date No.5	Configures the specific date (No.5) schedule.

3.7 Schedule Settings (Continued)

The schedule settings are shown below.

Item	Description
Schedule	Click the [Enable] check box to enable the schedule.
Date (Month/Day)	Configures the month and date. This item appears only when Specific date (No. 1-5) is selected.

Click the **[Apply]** button to save the settings.

The current event settings are displayed on the schedule list. To add additional functions and events, set the following items.

Item	Description
Time	Configures the time to execute commands.
Command [Parameter]	Configures the commands to be executed.
Power	Configures the parameters for power control.
Input Source	Configures the parameters for input switching.
My Image	Configures the parameters for My Image data display. (📖70)
Messenger	Configures the parameters for Messenger data display. (📖72)
Slideshow	Configures the Start/Stop parameters for the Slideshow.

Click the **[Register]** button to add new commands to the schedule list.

Click the **[Delete]** button to delete commands from the schedule list.

Click the **[Reset]** button to delete all commands and reset the schedule settings from the schedule list.

3.7 Schedule Settings (Continued)

- NOTE** • After the projector is moved, check the date and time set for the projector before configuring the schedules. Strong shock may make the date and time settings (📖58) get out of tune.
- Events “**My Image**” and “**Messenger**” will not be executed appropriately but result in “schedule execution error” status in case lamp does not light or/and display data are not stored in the projector at the scheduled event execution time.
 - Events “**Input Source**” and “**My Image**” will not be executed if security feature is enabled and the projector is locked due to the feature.
 - Certain error state in the projector (such as temperature error, lamp error) will prevent the projector from appropriate execution of scheduled functions/events.
 - If no USB memory device is inserted to the projector or no image data for display exists at the scheduled event time, a schedule execution error occurs against the scheduled Slideshow event.
 - When you start the Slideshow, input source will be automatically switched to the **USB TYPE A** port.
 - Image files stored in the root directory of the USB memory device will be displayed for the scheduled Slideshow.
 - Please refer to 📖 “**Troubleshooting**” in the *User's Manual – Operating Guide* in case scheduled functions/events are not executed appropriately as you've set.

3.8 Date/Time Settings

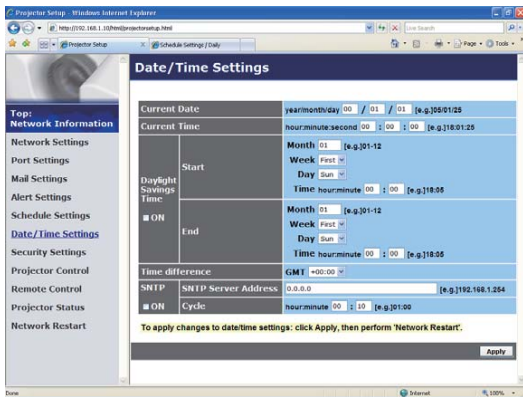

Displays and configures the date and time settings.

Item	Description				
Current Date	Configures the current date in year/month/day format.				
Current Time	Configures the current time in hour:minute:second format.				
Daylight Savings Time	Click the [ON] check box to enable daylight savings time and set the following items.				
Start	Configures the date and time daylight savings time begins.				
Month	Configures the month daylight savings time begins (1~12).				
Week	Configures the week of the month daylight savings time begins (First, 2, 3, 4, Last).				
Day	Configures the day of the week daylight savings time begins (Sun, Mon, Tue, Wed, Thu, Fri, Sat).				
Time	<table border="0"> <tr> <td>hour</td> <td>Configures the hour daylight savings time begins (0 ~ 23).</td> </tr> <tr> <td>minute</td> <td>Configures the minute daylight savings time begins (0 ~ 59).</td> </tr> </table>	hour	Configures the hour daylight savings time begins (0 ~ 23).	minute	Configures the minute daylight savings time begins (0 ~ 59).
hour	Configures the hour daylight savings time begins (0 ~ 23).				
minute	Configures the minute daylight savings time begins (0 ~ 59).				
End	Configures the date and time daylight savings time ends.				
Month	Configures the month daylight savings time ends (1 ~ 12).				
Week	Configures the week of the month daylight savings time ends (First, 2, 3, 4, Last).				
Day	Configures the day of the week daylight savings time ends (Sun, Mon, Tue, Wed, Thu, Fri, Sat).				
Time	<table border="0"> <tr> <td>hour</td> <td>Configures the hour daylight savings time ends (0 ~ 23).</td> </tr> <tr> <td>minute</td> <td>Configures the minute daylight savings time ends (0 ~ 59).</td> </tr> </table>	hour	Configures the hour daylight savings time ends (0 ~ 23).	minute	Configures the minute daylight savings time ends (0 ~ 59).
hour	Configures the hour daylight savings time ends (0 ~ 23).				
minute	Configures the minute daylight savings time ends (0 ~ 59).				

3.8 Date/Time Settings (Continued)

Item	Description
Time difference	Configures the time difference. Set the same time difference as the one set on your computer. If unsure, consult your IT manager.
SNTP	Click the [ON] check box to retrieve Date and Time information from the SNTP server and set the following items.
SNTP Server Address	Configures the SNTP server address in IP format. <ul style="list-style-type: none"> The address allows not only IP address but also domain name if the valid DNS server is setup in the Network Settings. The maximum length of host or domain name is up to 255 characters.
Cycle	Configures the interval at which to retrieve Date and Time information from the SNTP server (hour:minute).

Click the **[Apply]** button to save the settings.

NOTE • The new configuration settings are activated after restarting the network connection. When the configuration settings are changed, you must restart the network connection. You can restart the network connection by clicking the **[Network Restart]** on the main menu.

- If you connect the projector to an existing network, consult a network administrator before setting server addresses.
- To enable the SNTP function, the time difference must be set.
- The projector will retrieve Date and Time information from the time server and override time settings when SNTP is enabled.
- The internal clock's time may not remain accurate. Using SNTP is recommended to maintain accurate time.

3.9 Security Settings

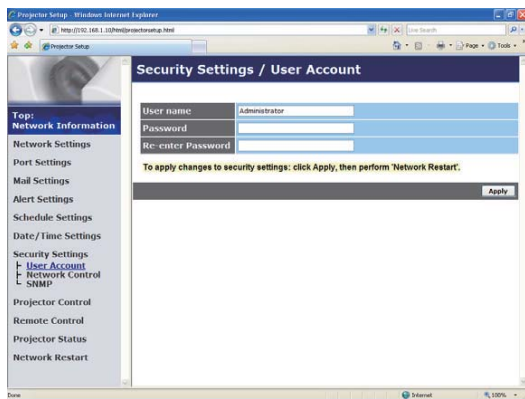

Displays and configures passwords and other security settings.

Item	Description
User Account	Configures the user name and password.
User name	Configures the user name. The length of the text can be up to 32 alphanumeric characters.
Password	Configures the password. The length of the text can be up to 255 alphanumeric characters.
Re-enter Password	Reenter the above password for verification.
Network Control	Configures the Authentication password for the command control.
Authentication Password	Configures the Authentication password. The length of the text can be up to 32 alphanumeric characters.
Re-enter Authentication Password	Reenter the above password for verification.
SNMP	Configures the community name if SNMP is used.
Community name	Configures the community name. The length of the text can be up to 64 alphanumeric characters.

Click the **[Apply]** button to save the settings.

NOTE • The new configuration settings are activated after restarting the network connection. When the configuration settings are changed, you must restart the network connection. You can restart the network connection by clicking the **[Network Restart]** on the main menu.

- Only numbers '0-9' and alphabet 'a-z', 'A-Z' can be used.

3.10 Projector Control

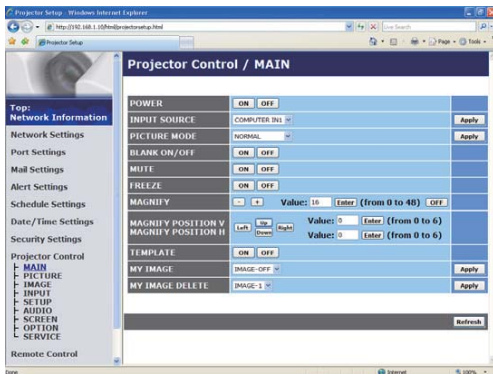

The items shown in the table below can be performed using the Projector Control menu. Select an item using the up and down arrow keys on the computer.

Most of the items have a submenu. Refer to the table below for details.

NOTE • The setting value may not match with the actual value if the user changes the value manually. In that case, please refresh the page by clicking the **[Refresh]** button.

Controls the projector.

Item	Description
MAIN	
POWER	Turns the power on/off.
INPUT SOURCE	Selects the input source.
PICTURE MODE	Selects the picture mode setting.
BLANK ON/OFF	Turns Blank on/off.
MUTE	Turns Mute on/off.
FREEZE	Turns Freeze on/off.
MAGNIFY	Controls the magnify setting. In some input signal sources, it might stop “Magnify” even though it does not reach to maximum setting value.
MAGNIFY POSITION V	Adjusts the vertical magnify position.
MAGNIFY POSITION H	Adjusts the horizontal magnify position.
TEMPLATE	Turns template on/off.
MY IMAGE	Selects MY IMAGE data.
MY IMAGE DELETE	Deletes MY IMAGE data.

3.10 Projector Control (Continued)

Item	Description
PICTURE	
BRIGHTNESS	Adjusts the brightness setting.
CONTRAST	Adjusts the contrast setting.
GAMMA	Selects the gamma setting.
COLOR TEMP	Selects the color temperature setting.
COLOR	Adjusts the color setting.
TINT	Adjusts the tint setting.
SHARPNESS	Adjusts the sharpness setting.
ACTIVE IRIS	Selects the active iris setting. (This item is available only for CP-X2511N, CP-X3011N or CP-X4011N.)
MYMEMORY SAVE	Saves the MyMemory data.
MYMEMORY RECALL	Recalls the MyMemory data.
IMAGE	
ASPECT	Selects the aspect setting.
OVER SCAN	Adjusts the over scan setting.
V POSITION	Adjusts the vertical position.
H POSITION	Adjusts the horizontal position.
H PHASE	Adjusts the horizontal phase.
H SIZE	Adjusts the horizontal size.
AUTO ADJUST EXECUTE	Performs the automatic adjustment.
INPUT	
PROGRESSIVE	Selects the progressive setting.
VIDEO NR	Selects the video noise reduction setting.
COLOR SPACE	Selects the color space.
COMPONENT	Selects the COMPONENT port setting.
S-VIDEO FORMAT	Selects the s-video format setting.
C-VIDEO FORMAT	Selects the video format setting.
HDMI FORMAT	Selects the HDMI format setting.
HDMI RANGE	Selects the HDMI range setting.
COMPUTER IN1	Selects the COMPUTER IN1 input signal type.
COMPUTER IN2	Selects the COMPUTER IN2 input signal type.
FRAME LOCK - COMPUTER IN1	Turns the FRAME LOCK-COMPUTER IN1 function on/off.
FRAME LOCK - COMPUTER IN2	Turns the FRAME LOCK-COMPUTER IN2 function on/off.
FRAME LOCK - HDMI	Turns the FRAME LOCK-HDMI function on/off.

3.10 Projector Control (Continued)

Item	Description
SETUP	
AUTO KEYSTONE EXECUTE	Performs the automatic keystone distortion setting.
KEYSTONE V	Adjusts the vertical keystone distortion setting.
AUTO ECO MODE	Turns on/off the automatic eco mode function.
ECO MODE	Selects the eco mode.
MIRROR	Selects the mirror status.
STANDBY MODE	Selects the standby mode.
MONITOR OUT - COMPUTER IN1	Assigns the MONITOR OUT when the COMPUTER IN1 input port is selected.
MONITOR OUT - COMPUTER IN2	Assigns the MONITOR OUT when the COMPUTER IN2 input port is selected.
MONITOR OUT - LAN	Assigns the MONITOR OUT when the LAN input port is selected.
MONITOR OUT - USB TYPE A	Assigns the MONITOR OUT when the USB TYPE A input port is selected.
MONITOR OUT - USB TYPE B	Assigns the MONITOR OUT when the USB TYPE B input port is selected.
MONITOR OUT - HDMI	Assigns the MONITOR OUT when the HDMI input port is selected.
MONITOR OUT - COMPONENT	Assigns the MONITOR OUT when the COMPONENT input port is selected.
MONITOR OUT - S-VIDEO	Assigns the MONITOR OUT when the S-VIDEO input port is selected.
MONITOR OUT - VIDEO	Assigns the MONITOR OUT when the VIDEO input port is selected.
MONITOR OUT - STANDBY	Assigns the MONITOR OUT in the standby mode.

3.10 Projector Control (Continued)

Item	Description
AUDIO	
VOLUME	Adjusts the volume setting.
SPEAKER	Turns the built-in speaker on/off.
AUDIO SOURCE - COMPUTER IN1	Assigns the AUDIO SOURCE - COMPUTER IN1 input port.
AUDIO SOURCE - COMPUTER IN2	Assigns the AUDIO SOURCE - COMPUTER IN2 input port.
AUDIO SOURCE - LAN	Assigns the AUDIO SOURCE - LAN input port.
AUDIO SOURCE - USB TYPE A	Assigns the AUDIO SOURCE - USB TYPE A input port.
AUDIO SOURCE - USB TYPE B	Assigns the AUDIO SOURCE - USB TYPE B input port.
AUDIO SOURCE - HDMI	Assigns the AUDIO SOURCE - HDMI input port.
AUDIO SOURCE - COMPONENT	Assigns the AUDIO SOURCE - COMPONENT input port.
AUDIO SOURCE - S-VIDEO	Assigns the AUDIO SOURCE - S-VIDEO input port.
AUDIO SOURCE - VIDEO	Assigns the AUDIO SOURCE - VIDEO input port.
AUDIO SOURCE - STANDBY	Assigns the AUDIO SOURCE in the standby mode.
HDMI AUDIO	Selects the HDMI audio setting.
MIC LEVEL	Selects the microphone level.
MIC VOLUME	Adjusts the microphone volume setting.
SCREEN	
LANGUAGE	Selects the language for the OSD.
MENU POSITION V	Adjusts the vertical Menu position.
MENU POSITION H	Adjusts the horizontal Menu position.
BLANK	Selects the Blank mode.
START UP	Selects the start up screen mode.
MyScreen LOCK	Turns MyScreen lock function on/off.
MESSAGE	Turns the message function on/off.
TEMPLATE	Selects the template setting.
C.C. - DISPLAY	Selects Closed Caption DISPLAY setting.
C.C. - MODE	Selects Closed Caption MODE setting.
C.C. - CHANNEL	Selects Closed Caption CHANNEL setting.

3.10 Projector Control (Continued)

Item	Description
OPTION	
AUTO SEARCH	Turns the automatic signal search function on/off.
AUTO KEYSTONE	Turns the automatic keystone distortion correction function on/off.
DIRECT POWER ON	Turns the direct power on function on/off.
AUTO POWER OFF	Configures the timer to shut off the projector when no signal is detected.
USB TYPE B	Selects the USB TYPE B setting.
MY BUTTON-1	Assigns the functions for the MY BUTTON-1 button on the included remote control.
MY BUTTON-2	Assigns the functions for the MY BUTTON-2 button on the included remote control.
MY SOURCE	Selects the My Source setting.
REMOTE FREQ. - NORMAL	Turns the remote control signal frequency normal function on/off.
REMOTE FREQ. - HIGH	Turns the remote control signal frequency high function on/off.

3. Web Control

3.10 Projector Control (Continued)

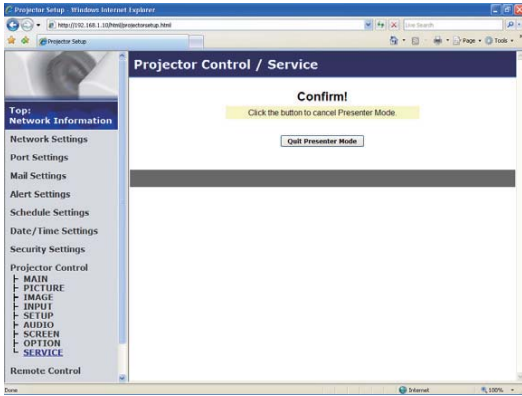

The items shown in the table below can be performed using the **Projector Control** menu. Click the **[QUIT PRESENTER MODE]**.

Item	Description
SERVICE	
QUIT PRESENTER MODE	Quit compulsorily from the Presenter mode.

3.11 Remote Control

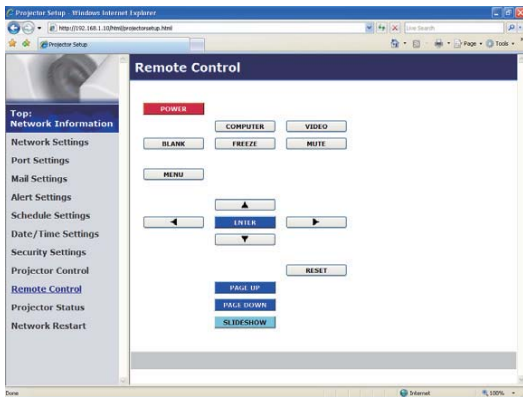

You can use your Web browser to control the projector.

- Do not attempt to control the projector with the projector's remote control and via your Web browser at the same time. It may cause some operational errors in the projector.

The functions on the bundled remote control are assigned to the Web Remote Control screen.

Item	Description
POWER	Assigned the same operation as STANDBY/ON button.
COMPUTER	Assigned the same operation as COMPUTER button.
VIDEO	Assigned the same operation as VIDEO button.
BLANK	Assigned the same operation as BLANK button.
FREEZE	Assigned the same operation as FREEZE button.
MUTE	Assigned the same operation as MUTE button.
MENU	Assigned the same operation as MENU button.
▲	Assigned the same operation as ▲ button.
▼	Assigned the same operation as ▼ button.
◀	Assigned the same operation as ◀ button.
▶	Assigned the same operation as ▶ button.
ENTER	Assigned the same operation as ENTER button.
RESET	Assigned the same operation as RESET button.
PAGE UP	Assigned the same operation as PAGE UP button.
PAGE DOWN	Assigned the same operation as PAGE DOWN button.
SLIDESHOW	Starts the Slideshow.

NOTE • The Web Remote Control does not support repeat function that performs an action while holding a button clicked down.

- Since the repeat function is not available, click the button repeatedly as many times as you require.
- Even if you hold the button clicked down for a while, the Web Remote Control sends your request command one time only. Release the button, then click it again.
- When the [**POWER**] button is pushed, a message window comes up to confirm the operation. If you wish to turn it off, push the [**OK**], otherwise push the [**Cancel**].
- The [**PAGE DOWN**] and [**PAGE UP**] buttons on the Web Remote Control cannot be used as mouse emulation function of the projector.

3.12 Projector Status

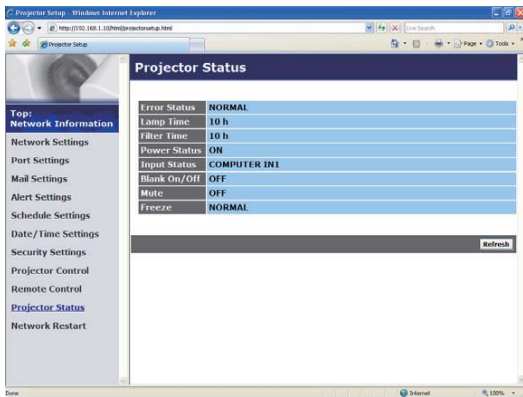

Displays and configures the current projector status.

Item	Description
Error Status	Displays the current error status
Lamp Time	Displays the usage time for the current lamp.
Filter Time	Displays the usage time for the current filter.
Power Status	Displays the current power status.
Input Status	Displays the current input signal source.
Blank On/Off	Displays the current Blank on/off status.
Mute	Displays the current Mute on/off status.
Freeze	Displays the current Freeze status.

3.13 Network Restart

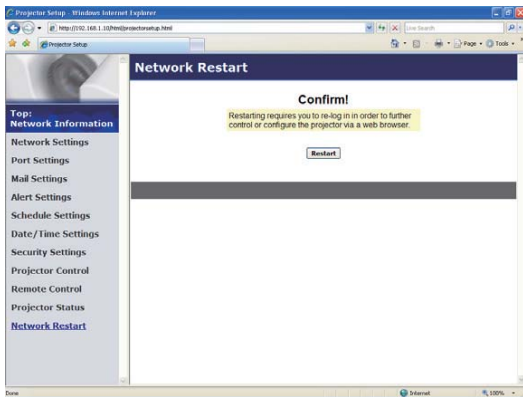

Restarts the projector's network connection.

Item	Description
Restart	Restarts the projector's network connection in order to activate new configuration settings.

NOTE • Restarting requires you to re-log on in order to further control or configure the projector via a web browser. Wait 30 seconds or more after clicking the **[Restart]** button to log on again.

4. My Image Function

4. My Image Function

The projector can display still images that are transferred via the network.

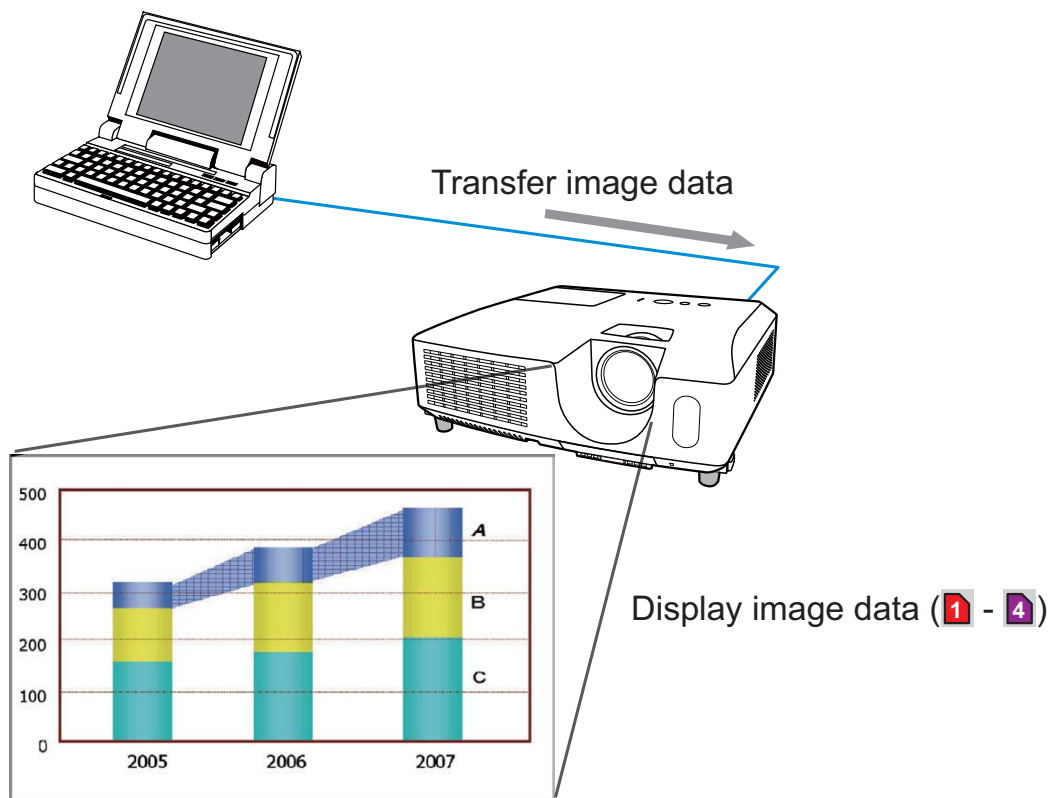

MY IMAGE transmission requires an exclusive application for your computer. “PJImg/Projector Image Tool” is necessary to use MY IMAGE transmission. It can be downloaded from the Hitachi web site (<http://hitachi.us/digitalmedia> or <http://www.hitachidigitalmedia.com>). Refer to the manual for the application for instructions.

To display the transferred image, select the MY IMAGE item in the NETWORK menu. For more information, please see the description of the MY IMAGE item of the NETWORK menu. ([📖 NETWORK menu in User’s Manual – Operating Guide](#))

- NOTE** • It is possible to allocate the image file up to 4 in the maximum.
- Using **MY BUTTON** that registered MY IMAGE can display transferred image. ([📖 OPTION menu in the User’s Manual – Operating Guide](#))
 - The image file also can be displayed by using schedule function from the web browser. Refer to item **7.3 Event Scheduling** ([📖 81](#)) in detail.
 - If you display MY IMAGE data on screen while you are using the USB Display function, the application for the USB Display will be closed. To restart the application, exit the MY IMAGE function, and then the software in the projector, LiveViewerLiteUSB.exe, will run again. ([📖 USB Display in the User’s Manual – Operating Guide](#))

4. My Image Function (Continued)

Configure the following items from a web browser when MY IMAGE function is used.

Example: If the IP address of the projector is set to **192.168.1.10**:

- 1) Enter "**http://192.168.1.10/**" into the address bar of the web browser.
- 2) Enter your user name and password, and then click the **[OK]**.
- 3) Click the **[Port Settings]** on the main menu.
- 4) Click the **[Enable]** check box to open the **My Image Port (Port: 9716)**. Click the **[Enable]** check box for the **[Authentication]** setting when authentication is required, otherwise clear the check box.
- 5) Click the **[Apply]** button to save the settings.

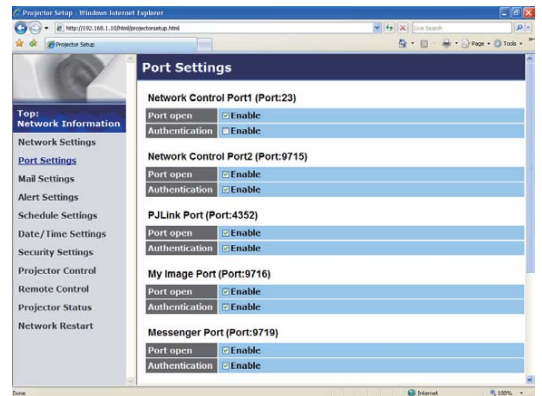

When the authentication setting is enabled, the following settings are required.

- 6) Click the **[Security Settings]** on the main menu.
- 7) Select the **[Network Control]** and enter the desired authentication password.
- 8) Click the **[Apply]** button to save the settings.

NOTE • The Authentication Password will be the same for **Network Control Port1 (Port: 23)**, **Network Control Port2 (Port: 9715)**, **PJLink™ Port (Port: 4352)**, **My Image Port (Port: 9716)** and **Messenger Port (Port: 9719)**.

- The new configuration settings are activated after restarting the network connection. When the configuration settings are changed, you must restart the network connection. You can restart the network connection by clicking the **[Network Restart]** on the main menu.

5. Messenger Function

5. Messenger Function

The projector can display the text data transferred via the network on the screen. The text data can be displayed on the screen in two ways that displays the text transferred from the computer on real time, and the other chooses and displays the text data from the ones once stored in the projector.

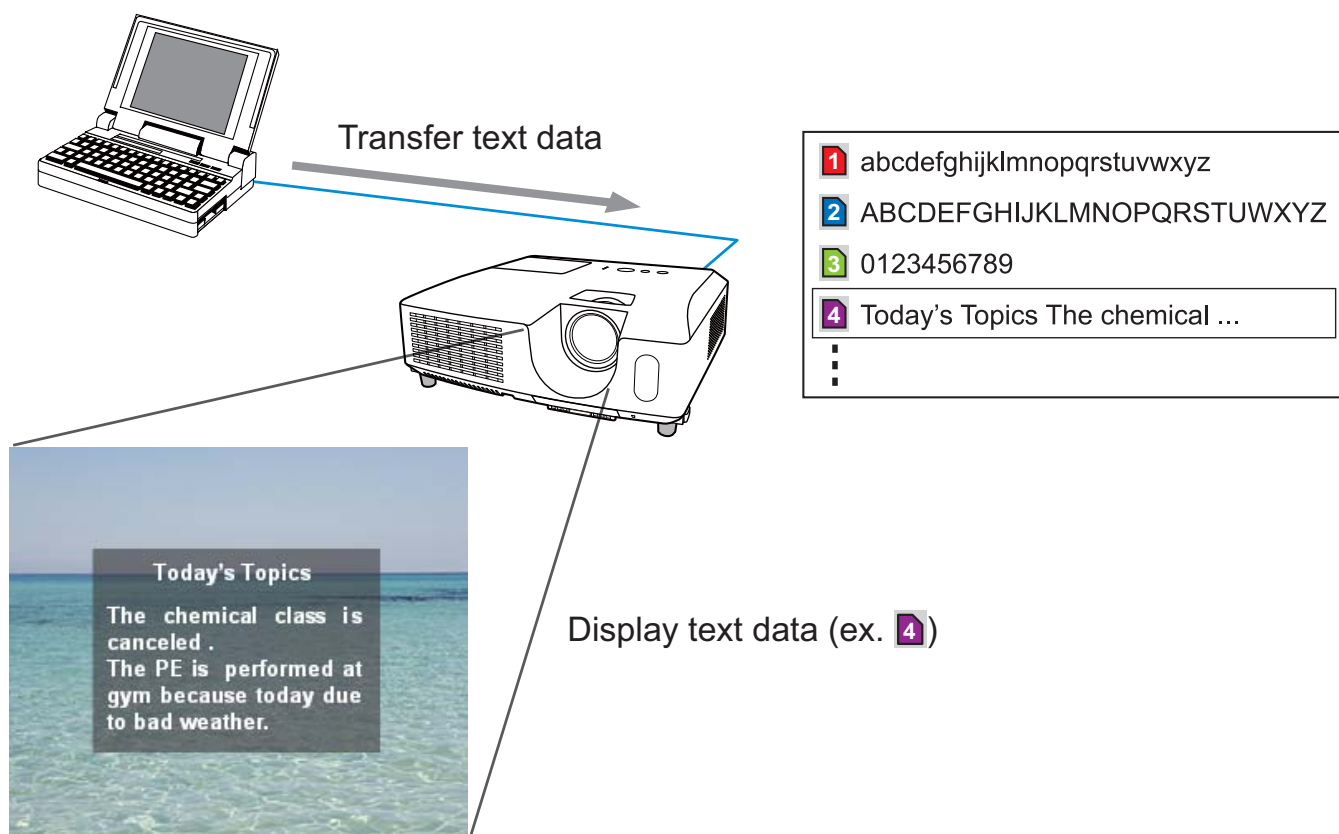

Messenger function requires an exclusive application for your computer. To edit, transfer and display the text data, use the application. You can download it from the Hitachi web site (<http://hitachi.us/digitalmedia> or <http://www.hitachidigitalmedia.com>). Refer to the manual for the application for the details of Messenger function and instructions of the application.

- NOTE** • It is possible to store the text data up to 12 in the maximum.
- Using **MY BUTTON** that registered MESSANGER can turn the displaying messenger text on/off. (📖 **OPTION menu in the User's Manual – Operating Guide**)
 - The text file also can be displayed by using schedule function via the web browser. Refer to item **7.3 Event Scheduling** (📖 81) for the detail.

5. Messenger Function (Continued)

Configure the following items from a web browser when Messenger function is used.

Example: If the IP address of the projector is set to **192.168.1.10**:

- 1) Enter "**http://192.168.1.10/**" into the address bar of the web browser.
- 2) Enter your user name and password, and then click the **[OK]**.
- 3) Click the **[Port Settings]** on the main menu.
- 4) Click the **[Enable]** check box to open the **Messenger Port (Port: 9719)**. Click the **[Enable]** check box for the **[Authentication]** setting when authentication is required, otherwise clear the check box.
- 5) Click the **[Apply]** button to save the settings.

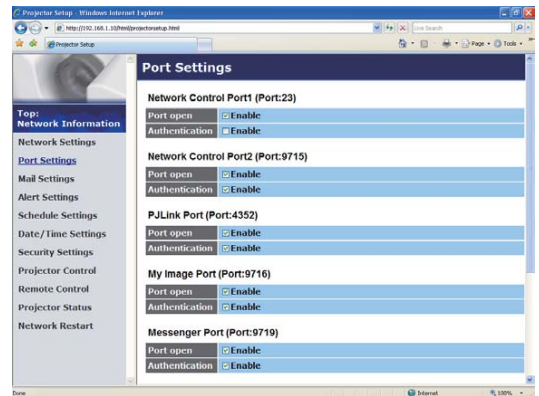

When the authentication setting is enabled, the following settings are required.

- 6) Click the **[Security Settings]** on the main menu.
- 7) Select the **[Network Control]** and enter the desired authentication password.
- 8) Click the **[Apply]** button to save the settings.

NOTE • The Authentication Password will be the same for **Network Control Port1 (Port: 23)**, **Network Control Port2 (Port: 9715)**, **PJLink™ Port (Port: 4352)**, **My Image Port (Port: 9716)** and **Messenger Port (Port: 9719)**.
 • The new configuration settings are activated after restarting the network connection. When the configuration settings are changed, you must restart the network connection. You can restart the network connection by clicking the **[Network Restart]** on the main menu.

6. Network Bridge Function

This projector is equipped with the NETWORK BRIDGE function to perform mutual conversion of a network protocol and a serial interface.

Using the NETWORK BRIDGE function, a computer that is connected with this projector by Ethernet communication can control an external device that is connected with this projector by RS-232C communication as a network terminal.

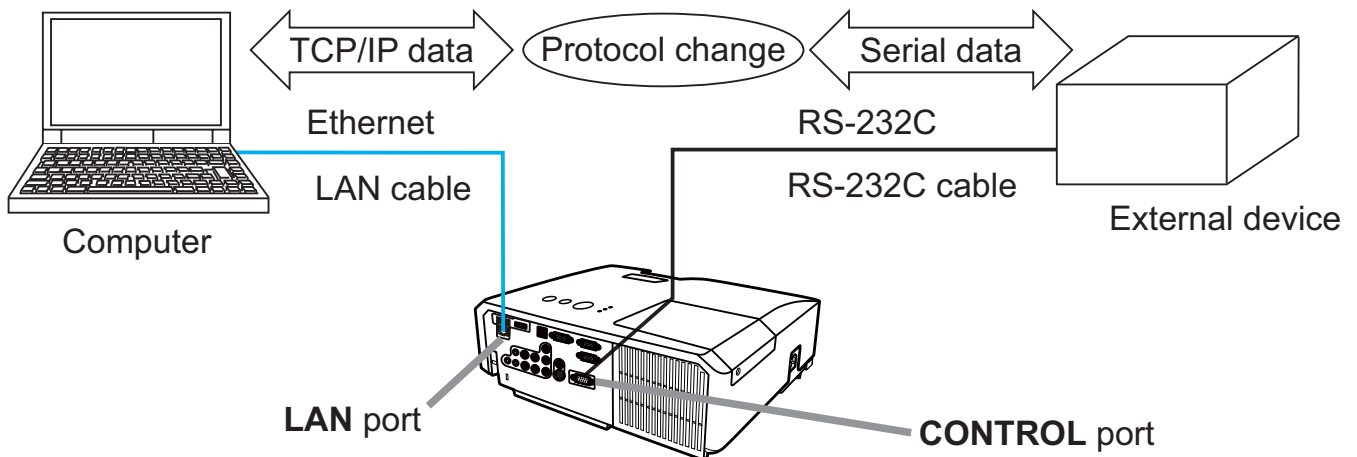

6.1 Connecting devices

- 1) Connect the projector's **LAN** port and the computer's LAN port with a LAN cable, for Ethernet communication.
- 2) Connect the projector's **CONTROL** port and the device's RS-232C port with an RS-232C cable, for RS-232C communication.

NOTE • Before connecting the devices, read the manuals for the devices to ensure the connection.

For RS-232C connection, check the specifications of each port and use the suitable cable. (📖 **“Connection to the ports” in the User’s Manual – Operating Guide (Technical)**)

6.2 Communication setup

To configure the setup of the communication using NETWORK BRIDGE for the projector, use items in the COMMUNICATION menu. Open the menu of the projector and select the OPTION - SERVICE - COMMUNICATION menu.

( **OPTION menu – SERVICE – COMMUNICATION in the User’s Manual – Operating Guide**)

- 1) Using the COMMUNICATION TYPE menu, select the NETWORK BRIDGE for the **CONTROL** port.
- 2) Using the SERIAL SETTINGS menu, select the proper baud rate and parity for the **CONTROL** port, according to the specification of the RS-232C port of the connected device.

Item	Condition
BAUD RATE	4800bps/9600bps/19200bps/38400bps
PARITY	NONE/ODD/EVEN
Data length	8 bit (fixed)
Start bit	1 bit (fixed)
Stop bit	1 bit (fixed)

- 3) Using the TRANSMISSION METHOD menu, set up the proper method for the **CONTROL** port according to your use.

NOTE • The OFF is selected for the COMMUNICATION TYPE as the default setting.

- Using the COMMUNICATION menu, set up the communication. Remember that an unsuitable setup could cause malfunction of communication.
- When COMMUNICATION TYPE is set to NETWORK BRIDGE, the **CONTROL** port doesn't accept RS-232C commands.

6.3 Communication port

For the NETWORK BRIDGE function, send the data from the computer to the projector with using the **Network Bridge Port** that is configured in the “Port Settings” of web browser. ( 50)

NOTE • Except for 9715, 9716, 9719, 9720, 5900, 5500, 4352 between 1024 and 65535 can be set up as the **Network Bridge Port** number. It is set to 9717 as the default setting.

6.4 Transmission method

The transmission method can be selected from the menus, only when the NETWORK BRIDGE is selected for the COMMUNICATION TYPE.

([📖](#) **OPTION menu – SERVICE – COMMUNICATION in the User’s Manual – Operating Guide**)

HALF-DUPLEX ↔ FULL-DUPLEX

6.4.1 HALF-DUPLEX

This method lets the projector make two way communication, but only one direction, either transmitting or receiving data, is allowed at a time.

The method does not allow the projector to receive the data from the computer while waiting for response data from an external device. After the projector receives the response data from an external device or the response limit time is past, the projector can receive the data from the computer.

That means that the projector controls transmitting and receiving the data to synchronize the communication.

To use the HALF-DUPLEX method, set up the RESPONSE LIMIT TIME following the instructions below.

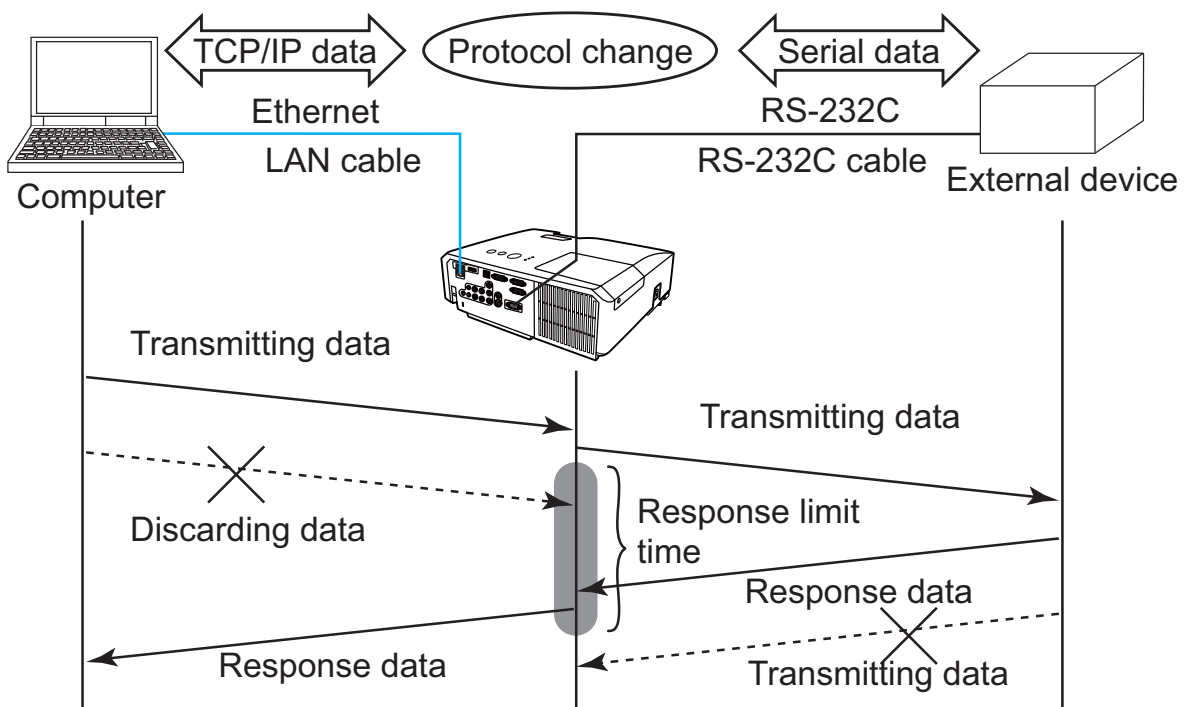

Using the RESPONSE LIMIT TIME menu, set the waiting time for response data from an external device. ([📖](#) **OPTION menu – SERVICE – COMMUNICATION in the User’s Manual – Operating Guide**)

OFF ↔ 1s ↔ 2s ↔ 3s (↔ OFF)

6.4 Transmission method (Continued)

NOTE • With using the HALF-DUPLEX method, the projector can send out 254 byte data as maximum at once.

- If it is not required to monitor the response data from an external device and the RESPONSE LIMIT TIME is set to OFF, the projector can receive the data from the computer and send it out to an external device continuously. The OFF is selected as the default setting.

6.4.2 FULL-DUPLEX

This method lets the projector make two way communication, transmitting and receiving data at the same time, without monitoring response data from an external device.

With using this method, the computer and an external device will send the data out of synchronization. If it is required to synchronize them, set the computer to make the synchronization.

NOTE • In case that the computer controls to synchronize transmitting and receiving the data, it may not be able to control an external device well depending on the processing status of the projector.

7. Other Functions

7.1 E-mail Alerts

The projector can automatically send an alert message to the specified e-mail addresses when the projector detects a certain condition that is requiring maintenance or detected an error.

NOTE • Up to five e-mail addresses can be specified.
• The projector may be not able to send e-mail if the projector suddenly loses power.

Mail Settings (📖52)

To use the projector's e-mail alert function, please configure the following items through a web browser.

Example: If the IP address of the projector is set to **192.168.1.10**:

- 1) Enter "**http://192.168.1.10/**" into the address bar of the web browser.
- 2) Enter your user name and password, and then click the **[OK]**.
- 3) Click the **[Mail Settings]** and configure each item. Refer to item **3.5 Mail Settings (📖52)** for further information.
- 4) Click the **[Apply]** button to save the settings.

NOTE • Click the **[Send Test Mail]** button in the **[Mail Settings]** to confirm that the e-mail settings are correct. The following mail will be delivered to the specified addresses.

Subject line	:Test Mail	<Projector name>
Text	:Send Test Mail	
	Date	<Testing date>
	Time	<Testing time>
	IP Address	<Projector IP address>
	MAC Address	<Projector MAC address>

7.1 E-mail Alerts (Continued)

- 5) Click the **[Alert Settings]** on the main menu to configure the E-mail Alerts settings.
- 6) Select and configure each alert item. Refer to item **3.6 Alert Setting** (53) for further information.
- 7) Click the **[Apply]** button to save the settings.

Failure/Warning e-mails are formatted as follows:

Subject line	:	<Mail title>	<Projector name>
Text	:	<Mail text>	
		Date	<Failure/Warning date>
		Time	<Failure/Warning time>
		IP Address	<Projector IP address>
		MAC Address	<Projector MAC address>

7.2 Projector Management using SNMP

The SNMP (Simple Network Management Protocol) enables to manage the projector information, which is a failure or warning status, from the computer on the network. The SNMP management software will be required on the computer to use this function.

NOTE • It is recommended that SNMP functions be carried out by a network administrator.

• SNMP management software must be installed on the computer to monitor the projector via SNMP.

SNMP Settings (📖50)

Configure the following items via a web browser to use SNMP.

Example: If the IP address of the projector is set to **192.168.1.10**:

- 1) Enter “**http://192.168.1.10/**” into the address bar of the web browser.
- 2) Enter your user name and password, and then click the **[OK]**.
- 3) Click the **[Port Settings]** on the main menu.
- 4) Click the **[Download MIB file]** to download a MIB file.

NOTE • To use the downloaded MIB file, specify the file by your SNMP manager.

- 5) Click the **[Enable]** check box to open the **SNMP Port**. Set the IP address to send the SNMP trap to when a Failure/Warning occurs.

NOTE • A Network Restart is required after the **SNMP Port** configuration settings have been changed. Click the **[Network Restart]** and configure the following items.

- 6) Click the **[Security Settings]** on the main menu.
- 7) Click the **[SNMP]** and set the community name on the screen that is displayed.

NOTE • A Network Restart is required after the **Community name** has been changed. Click the **[Network Restart]** and configure the following items.

- 8) Configure the settings for Trap transmission of Failures/Warnings. Click the **[Alert Settings]** on the main menu and select the Failure/Warning item to be configured.
- 9) Click the **[Enable]** check box to send out the SNMP trap for Failures/Warnings. Clear the **[Enable]** check box when SNMP trap transmission is not required.
- 10) Click the **[Apply]** button to save the settings.

7.3 Event Scheduling

The scheduling function enables to setup scheduled events including power on / power off. It enables to be “self-management” projector.

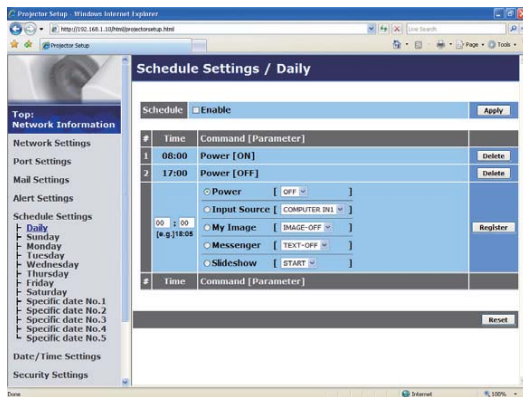

NOTE • You can schedule the following control events: Power, Input Source, My Image, Messenger, Slideshow. (📖56)

- The power on / off event has the lowest priority among the all events that are defined at the same time.
- There are 3 types of Scheduling, 1) daily 2) weekly 3) specific date. (📖55)
- The priority for scheduled events is as follows 1) specific date 2) weekly 3) daily.
- Up to five specific dates are available for scheduled events. Priority is given to those with the lower numbers when more than one event has been scheduled for the same date and time (e.g., ‘Specific date No. 1’ has priority over ‘Specific date No. 2’ and so on).
- Be sure to set the date and time before enabling scheduled events. (📖58)

7.3 Event Scheduling(Continued)

Schedule Settings (📖55)

Schedule settings can be configured from a web browser.

Example: If the IP address of the projector is set to **192.168.1.10**:

- 1) Enter “**http://192.168.1.10/**” into the address bar of the web browser.
- 2) Enter your user name and password, and then click the **[OK]**.
- 3) Click the **[Schedule Settings]** on the main menu and select the required schedule item. For example, if you want to perform the command every Sunday, please select the **[Sunday]**.
- 4) Click the **[Enable]** check box to enable scheduling.
- 5) Enter the date (month/day) for specific date scheduling.
- 6) Click the **[Apply]** button to save the settings.
- 7) After configure the time, command and parameters, click the **[Register]** to add the new event.
- 8) Click the **[Delete]** button when you want to delete a schedule.

There are three types of scheduling.

- 1) Daily: Perform the specified operation at a specified time every day.
- 2) Sunday ~ Saturday: Perform the specified operation at the specified time on a specified day of the week.
- 3) Specific date: Perform the specified operation on the specified date and time.

NOTE • In standby mode, the **POWER** indicator will flash green for approx. 3 seconds when at least 1 “Power ON” schedule is saved.

- When the schedule function is used, the power cord must be connected to the projector and the outlet. The schedule function does not work when the breaker in a room is tripped. The power indicator will lights orange or green when the projector is receiving AC power.

7.3 Event Scheduling(Continued)

Date/Time Settings (📖58)

The Date/Time setting can be adjusted via a web browser.

Example: If the IP address of the projector is set to **192.168.1.10**:

- 1) Enter “**http://192.168.1.10**” into the address bar of the web browser.
- 2) Enter your user name and password, and then click the **[OK]**.
- 3) Click the **[Date/Time Settings]** on the main menu and configure each item.
Refer to item **3.8 Date/Time Settings (📖58)** for further information.
- 4) Click the **[Apply]** button to save the settings.

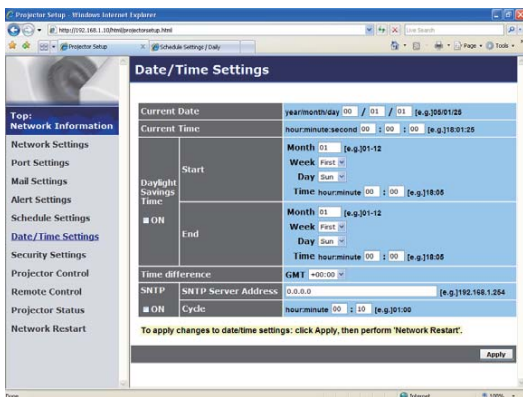

NOTE • The battery for the built in clock may be dead if the clock loses time even when the date and time have been set correctly. Replace the battery by following the instructions on replacing the battery.

(📖 *Replacing the internal clock battery in the User's Manual (concise)*)

- The internal clock's time may not remain accurate. Using SNTP is recommended to maintain accurate time.

7.4 Command Control via the Network

You can configure and control the projector via the network using RS-232C commands.

Communication Port

The following two ports are assigned for the command control.

TCP #23 (**Network Control Port1 (Port: 23)**)

TCP #9715 (**Network Control Port2 (Port: 9715)**)

NOTE • Command control is available only via the specified port above.

Command Control Settings (📖50)

Configure the following items from a web browser when command control is used.

Example: If the IP address of the projector is set to **192.168.1.10**:

- 1) Enter “**http://192.168.1.10/**” into the address bar of the web browser.
- 2) Enter your user name and password, and then click the **[OK]**.
- 3) Click the **[Port Settings]** on the main menu.

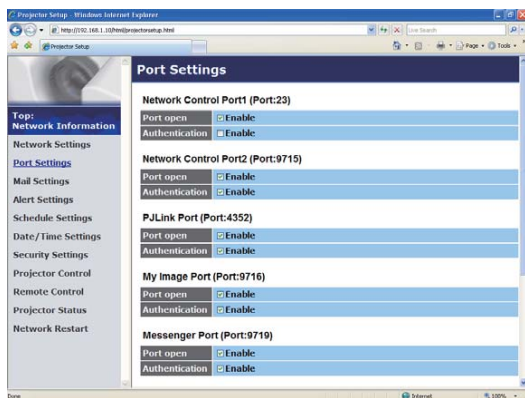

- 4) Click the **[Enable]** check box to open **Network Control Port1 (Port: 23)** to use TCP #23. Click the **[Enable]** check box for the **[Authentication]** setting when authentication is required, otherwise clear the check box.
- 5) Click the **[Enable]** check box to open **Network Control Port2 (Port: 9715)** to use TCP #9715. Click the **[Enable]** check box for the **[Authentication]** setting when authentication is required, otherwise clear the check box.
- 6) Click the **[Apply]** button to save the settings.

7.4 Command Control via the Network (Continued)

When the authentication setting is enabled, the following settings are required.
( 60)

- 7) Click the **[Security Settings]** on the main menu.
- 8) Click the **[Network Control]** and enter the desired authentication password.
* See NOTE.
- 9) Click the **[Apply]** button to save the settings.

NOTE • The Authentication Password will be the same for **Network Control Port1 (Port: 23)**, **Network Control Port2 (Port: 9715)**, **PJLink™ Port (Port: 4352)**, **My Image Port (Port: 9716)** and **Messenger Port (Port: 9719)**.
• The new configuration settings are activated after restarting the network connection. When the configuration settings are changed, you must restart the network connection. You can restart the network connection by clicking the **[Network Restart]** on the main menu.

7.4 Command Control via the Network (Continued)

Command Format

Command formats differ among the different communication ports.

- TCP #23

You can use the RS-232C commands without any changes. The reply data format is the same as the RS-232C commands. (📖 **“RS-232C Communication” in the User’s Manual – Operating Guide (Technical)**)
However, the following reply will be sent back in the event of authentication failure when authentication is enabled.

<Reply in the event of an authentication error>

Reply	Error code	
0x1F	0x04	0x00

- TCP #9715

Send Data format

The following formatting is added to the header (0 x 02), Data length (0 x 0D), Checksum (1 byte) and Connection ID (1 byte) of the RS-232C commands.

Header	Data length	RS-232Ccommand	Check Sum	Connection ID
0x02	0x0D	13 bytes	1 byte	1 byte

Header → 0x02, Fixed

Data length → RS-232C commands byte length (0x0D, Fixed)

RS-232C command → RS-232C commands that start with 0xBE 0xEF (13 bytes)

Check Sum → This is the value to make zero on the addition of the lower 8 bits from the header to the checksum.

Connection ID → Random value from 0 to 255 (This value is attached to the reply data)

7.4 Command Control via the Network (Continued)

Reply Data format

The connection ID (the data is same as the connection ID data on the sending data format) is attached to the RS-232C commands reply data.

<ACK reply>

Reply	Connection ID
0x06	1 byte

<NAK reply>

Reply	Connection ID
0x15	1 byte

<Error reply>

Reply	Error code	Connection ID
0x1C	2 bytes	1 byte

<Data reply>

Reply	Data	Connection ID
0x1D	2 bytes	1 byte

<Projector busy reply>

Reply	Status code	Connection ID
0x1F	2 bytes	1 byte

<Authentication error reply>

Reply	Authentication Error code		Connection ID
0x1F	0x04	0x00	1 byte

7.4 Command Control via the Network (Continued)

Automatic Connection Break

The TCP connection will be automatically disconnected after there is no communication for 30 seconds after being established.

Authentication

The projector does not accept commands without authentication success when authentication is enabled. The projector uses a challenge response type authentication with an MD5 (Message Digest 5) algorithm.

When the projector is using a LAN, a random 8 bytes will be returned if authentication is enabled. Bind this received 8 bytes and the Authentication Password and digest this data with the MD5 algorithm and add this in front of the commands to send.

Following is a sample if the Authentication Password is set to “password” and the random 8 bytes are “a572f60c”.

- 1) Select the projector.
- 2) Receive the random 8 bytes “a572f60c” from the projector.
- 3) Bind the random 8 bytes “a572f60c” and the Authentication Password “password” and it becomes “a572f60cpassword”.
- 4) Digest this bind “a572f60cpassword” with MD5 algorithm.
It will be “e3d97429adffa11bce1f7275813d4bde”.
- 5) Add this “e3d97429adffa11bce1f7275813d4bde” in front of the commands and send the data.
Send “e3d97429adffa11bce1f7275813d4bde”+command.
- 6) When the sending data is correct, the command will be performed and the reply data will be returned. Otherwise, an authentication error will be returned.

NOTE • As for the transmission of the second or subsequent commands, the authentication data can be omitted when the same connection.

8. Troubleshooting

Problem		Likely Cause	Things to Check	Reference Page Number
No image		The projector is not turned on.	Is the projector's lamp on?	*17
		The projector's input source isn't switched to LAN.	Is the projector switched to LAN?	*18, *19
Connection to the Network	The projector that you want to connect to is nowhere to be found on the list of available projectors	The computer and/or projector's network settings are not configured correctly.	Check the network configurations of the computer and projector. If you change the projector's settings, turn off the projector's AC power and then turn it on again. If you simply put the projector in STANDBY power mode and then turn it on again, the new settings might not take effect.	8
		Firewall software other than Windows Firewall is installed in your computer.	Refer to the manual for the firewall software and take one of the following actions: - Exclude the "LiveViewer" from blocking item list - Disable the firewall while using the "LiveViewer"	—
	Can't communicate	The computer and/or projector's network settings are not configured correctly.	Check the network configurations of the computer and projector.	8
		The projector input port isn't switched to LAN.	Check the projector's input port setting.	*18, *19
		An access point is used, and your computer is connected to the access point via wireless LAN.	Use network utilities that may come with your computer or wireless LAN card to establish wireless network connection. For detail, refer to the manual of the computer or the card.	—

(continued on next page)

* User's Manual - Operating Guide

8. Troubleshooting (Continued)

Problem		Likely Cause	Things to Check	Reference Page Number
Network Presentation	The projected image is rather slow compared to that of the computer	The projector isn't capable of relaying dynamic images such as PowerPoint® animation at full speed.	Switching the priority to 'Transmission Speed' under the options menu may help to improve speed.	41
		The compression rate being used for transferring the images is too low.	Switching the priority to 'Transmission Speed' under the options menu may help to improve speed.	41
	No Image	Using Photo Gallery Slide Show in Windows Vista.	The "LiveViewer" cannot send computer screen data while using Windows Vista Photo Gallery Slide Show. Please close Photo Gallery Slide Show before using the "LiveViewer".	—
	Can't display the movies correctly.	In some combinations of computer's video card and application software, there is a possibility that true image - especially movies played by media player - cannot be transferred to the projector with the "LiveViewer".	If there is a video acceleration level adjustment function in your application, please try to adjust it. Refer your application manual in detail.	—
	Network connection between the computer and projector is disconnected when computer display resolution is changed during Network Presentation.	The computer-Projector network connection might be disconnected when computer display resolution is changed while displaying picture.	Please re-connect using "Connect button" after changing computer display resolution, or change display resolution before connecting with the "LiveViewer".	37
	Images contain lots of interference.	The compression rate being used for transferring the images is too high.	Try setting the priority to 'Image Quality' in the "LiveViewer" Option menu. You may experience a drop in speed.	41
	Two cursors appear	Cursor of the computer and cursor of the projector are displayed coming in succession.	Turn off the cursor Emulation of the "LiveViewer" option.	41
	No cursor appears	Some computers do not display the cursor in the "LiveViewer".	Turn on the cursor Emulation of the "LiveViewer" option.	41
	Neither transparency nor translucency effects (Glass)	Using the "LiveViewer" with Windows Aero mode.	The "LiveViewer" does not support these features of Windows Vista Aero.	—

8. Troubleshooting (Continued)

Problem	Likely Cause	Things to Check	Reference Page Number
Others - Information from the projector to computer is not correct or completed - The projector does not respond - Image on screen is frozen.	Communication between the projector and computer is not working well. NETWORK Functions of the projector is not working well.	Try "NETWORK RESTART" in SERVICE menu under the NETWORK menu.	*66

* User's Manual - Operating Guide

9. Warranty and after-sales service

9. Warranty and after-sales service

If a problem occurs with the equipment, please read **8. Troubleshooting** (📖 89) section first and review all suggested check points. After that, please contact your dealer or service company, if you still have the problem. They will tell you what warranty condition is applied.