

Notices

Reproduction or reprinting, without permission, of this manual or any part thereof is prohibited.

The contents of this manual are subject to change without prior notice.

Every effort has been made to ensure that this manual is complete and correct. However, should any questionable points, mistakes, etc., come to your attention, please inform the vendor.

Please be advised in advance that this company will assume no responsibility for losses, etc., resulting from the operation of this product, regardless of the preceding clauses.

Disclaimers

Hitachi Software Engineering Co., Ltd. assumes no liability and makes no warranty, either express or implicit, regarding the contents of this user's guide.

Also, the company makes no warranty as to the product's suitability, merchantability or fitness for a particular intended use.

All products of Hitachi Software Engineering Co., Ltd., described in this user's guide are presently for sale or are site-licensed.

Users who purchased the aforesaid product(s) will bear the costs of all required services, repairs, and damages resulting from defects in this product, and will bear the costs of direct or indirect damages (including the loss of profits or required information) that resulted from the product defects.

Moreover, Hitachi Software Engineering Co., Ltd., retains the right to revise this user's guide and to modify the contents thereof, without any obligation to notify anyone.

Product Assurance Provisions

This product is limited to use in the country where the user bought this product.

For warranty details, refer to Appendix 3.6 at the end of this user's guide.

This First edition of the user's guide (T19WX-EU090601) is for the following products:

70.53K02G00x (StarBoard T-19WX) , AH00219

* The term "x" as used in this manual denotes the model No. of the product.

The StarBoard T-19WX incorporates WALTOP's 19-inch LCD monitor integrated digitizer technology.

Windows is a trademark of Microsoft Corporation (U.S.) and in other countries.

Other trademarks and product names are trademarks and/or registered trademarks of their respective holders.

Manual Creation Dates

June 2009, First Edition

T19WX-EU090601

All Rights Reserved. Copyright © 2009, Hitachi Software Engineering Co., Ltd.

Safe Handling

Markings and Symbols

Various markings and symbols are used in this user's guide and on this product, to ensure the safe and correct use of this product and to prevent personal injury and property damage. These symbols and their meanings are as explained below. Understand the information well before reading the body of the user's guide.



This is the safety alert symbol. It is used to alert you to potential personal injury hazards. Obey all safety messages that follow this symbol to avoid possible injury or death.



WARNING

Indicates a hazardous situation which, if not avoided, could result in death or serious injury.



CAUTION

Indicates a hazardous situation which, if not avoided, could result in minor or moderate injury.

NOTICE

Indicates a hazardous situation which, if not avoided, could result in damage not related to personal injury.



This symbol draws attention to cautions (including warnings).



This symbol indicates something prohibited.



This symbol indicates something that must be done.

Safety Precautions

Always comply with them



WARNING

Securely insert the power plug into the power socket.



If it is not plugged in securely, overheating will occur, possibly resulting in electric shock or fire.

Before moving this product, detach the power plug and the power cable.



The power cable might be damaged, possibly resulting in electric shock or fire.

Do not plug in the power plug with a wet hand.



Electric shock will result.

When plugging in or unplugging the power plug, hold the plug.



If the power cord is pulled, it might be damaged, possibly resulting in electric shock or fire.

Before cleaning this product, unplug the power plug.



Electric shock sometimes results.

Periodically clean the power plug to remove dust.



If a dirty plug is plugged into an outlet, fire or electric shock might result.

Do not use this product near water.



Electric shock will result.

Be careful about the locations of the power cable, etc.



The power cable might trip someone, possibly causing the product to fall, etc., thereby causing injury or product failure. Be careful with their locations.

Do not damage, break, process, or forcibly bend the power cable.



The power cable will be damaged, resulting in fire or electric shock.

Use the product at the indicated power supply voltage.



If the product is used at a power supply voltage other than the one indicated, it will fail, resulting in fire or electric shock.

Safety Precautions

Always comply with them



WARNING

Do not use a power cable other than the accessory power cable.



If a power cable other than the accessory power cable is used, fire or electric shock might result.

Do not open or alter the cabinet of this product.



The cabinet contains high-voltage areas, so electric shock or other injury will result.



Unplug the power plug if you do not plan on using the product for an extended period of time.



Failure to do so could result in a fire.

Do not leave this product or any of its accessories on the floor.



Someone might step on it and break it, or might be injured by tripping on it.

Only place specified objects on this product.



If a liquid or a metal object enters this product, electric shock or fire might result. If either should enter, unplug the power plug from the outlet and contact your dealer.



Do not dispose the equipment as unsorted municipal waste, but use the return and collection systems available.



Contact your dealer for details.

Do not place a heavy object on the power cable, heat or pull it.



The power cable will be damaged, causing fire or electric shock.

Safety Precautions

Always comply with them

**WARNING**

In the following cases, unplug the product from the AC Adaptor socket and ask the technical support of Hitachi Software.

- a. After the power cord or AC Adaptor plug is damaged.
- b. After liquid is spilled onto the main unit.
- c. After the main unit is exposed to rain or water.
- d. After this product malfunctions, even when operated according to the instruction manual. Adjust this product within the ranges specified in the instruction manual. Do not make other adjustments. A qualified service representative is required to correct improper adjustments.
- e. After this product falls or after its cabinet is damaged.
- f. After the functionality of this product changes and repair by a service representative is considered necessary.

NOTICE

Do not use this product in a location with high temperature or high humidity.

This product's usage environment conditions:

Temp.: 50 °F to 95 °F

(10°C to 35 °C)

Humidity: 30% to 80%

(But no condensation may be allowed to form.)



Careful thought was given to the cautions on this device and in this user's guide. However, unanticipated circumstances might occur. When operating this product, users themselves must exercise caution as well as follow instructions.

 WARNING	
Warning Details	Page
Use the AC Adaptor supplied with this product. Use only AC Adaptor or power cables specified by the manufacturer. Use of improper adaptors or cables can damage the product or cause a fire.	1-9

 CAUTION	
Caution Details	Page
Hold the body firmly and slide the stand slowly when adjusting it. When adjusting the stand, if you pull up the lever without holding onto the body, the body may move suddenly, resulting in unexpected injuries or damage to the body.	1-7

NOTICE	
Warning Details	Page
Securely connect the earth to the earth terminal. Failing to do so may result in an electric shock or malfunction.	1-9
When changing the battery, be careful not to close the pen's rear part too forcefully. If too much force is applied when closing the rear part of the stylus pen, the pen may be damaged.	2-4

Contents

1. Introduction	1-1
1.1 Preparations before Use	1-1
1.1.1 Product Overview.....	1-1
1.1.2 Features	1-1
1.2 Parts Check	1-2
1.3 Part Names and Functions	1-3
1.3.1 Front Screen	1-3
1.3.2 Front Switch Panel.....	1-4
1.3.3 Connector Panel	1-5
1.3.4 Function Buttons	1-6
1.4 Assembly and Setup.....	1-7
1.4.1 Adjusting the Stand	1-7
1.4.2 How to Use the Pen Holder.....	1-8
1.4.3 Connection Procedure	1-9
2. Usage Procedures	2-1
2.1 Turning the StarBoard On.....	2-1
2.2 Using the Stylus Pen	2-2
2.2.1 How to Use the Stylus Pen.....	2-2
2.2.2 Basic Stylus Pen Operations.....	2-2
2.2.3 Stylus Pen Settings.....	2-3
2.2.4 Changing the Battery in the Stylus Pen.....	2-4
2.2.5 Replacing the Stylus Pen Tip.....	2-5
2.3 Using the OSD Menu.....	2-6
2.3.1 OSD Buttons and Their Functions	2-6
2.3.2 OSD Adjustment Options.....	2-7
3. Appendix	3-1
3.1 Troubleshooting	3-1
3.2 System Specifications.....	3-4
3.3 How to Take Care of the StarBoard	3-6
3.4 Consumables.....	3-6
3.5 LCD Panel	3-6
3.6 Provisions of Product Warranty	3-7

1. Introduction

1.1 Preparations before Use

This section covers preparations before using the StarBoard. Please read this section thoroughly if you are using the StarBoard for the first time.

1.1.1 Product Overview

StarBoard T-19WX is a convenient and easy-to-use tablet-type interactive electronic board that lets you operate a PC with a stylus pen, and write text and images to a PC screen in real time as well as simultaneously input those to the PC. Those features work when the included software is set up on a PC connected to the StarBoard.

1.1.2 Features

- Write directly to the PC screen
Use the stylus pen just like a mouse to operate the PC on the screen displayed on the LCD monitor. The StarBoard Software allows text and images to be written to the PC, and allows the text and images to be input to the PC as digital data in real time. That data can then be saved, printed, or otherwise manipulated.

- Use as soon as the PC is started up
The StarBoard can be used as soon as the PC is started up, by just installing the StarBoard Software package included.

- Compatible with presentations in PowerPoint
Text and images can be written into presentation materials prepared in Microsoft PowerPoint. That allows you to further enhance presentation expression. Presentations can also be linked to remote meetings.

- Write on video images
Write text and images to screens of captured video. That allows for easy use of video materials in classes and presentations.

- Eight function buttons
Standard functions used frequently in the StarBoard Software are assigned to the eight function buttons located on the top left side of the StarBoard. Those buttons act as shortcuts when using the software.

1.2 Parts Check

After unpacking, make sure that all of the following parts are included.

Parts

No.	Name	Qty.
(1)	19-inch Tablet monitor	1
(2)	Stylus pen	1
(3)	AAA alkaline dry cell	1
(4)	Spare pen tips	2
(5)	AC adapter	1
(6)	Power cable	(*1)
(7)	RGB cable (1.8m)	1
(8)	USB cable (1.5m)	1
(9)	Audio cable (stereo mini-plug)	1
(10)	Pen tip replacement pin set	1
(11)	StarBoard Software x.x (CD-ROM) (*2)	3
(12)	StarBoard T-19WX User's Guide (this manual)	1
(13)	StarBoard Software x.x Installation Guide (*2)	1
(14)	Warranty Sheet	1

(*1) The quantity of power cable is depended on the region.

(*2) The term "x.x." as used in this manual denotes the same version as the software which is included with the accessories.

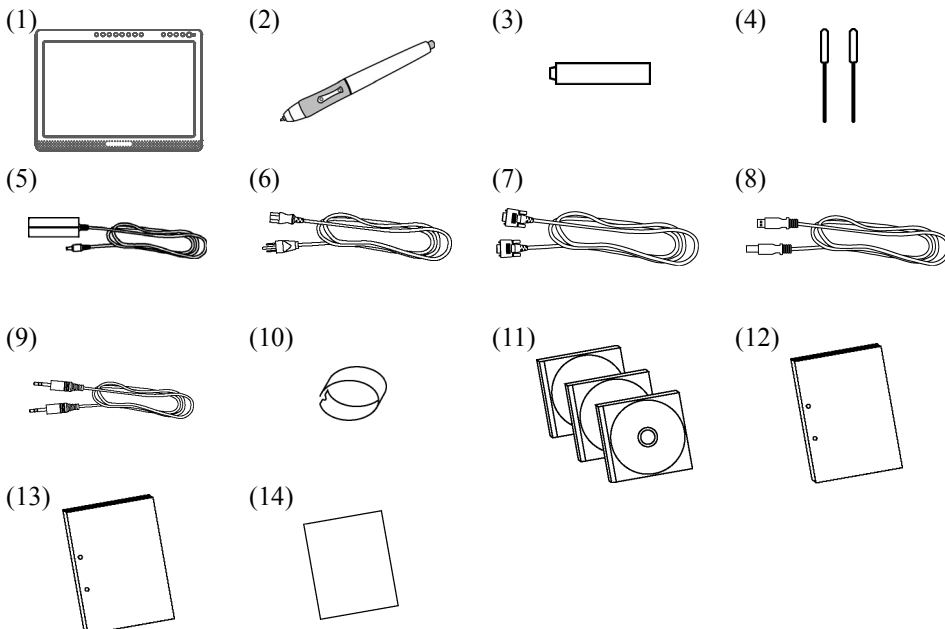

1.3 Part Names and Functions

1.3.1 Front Screen

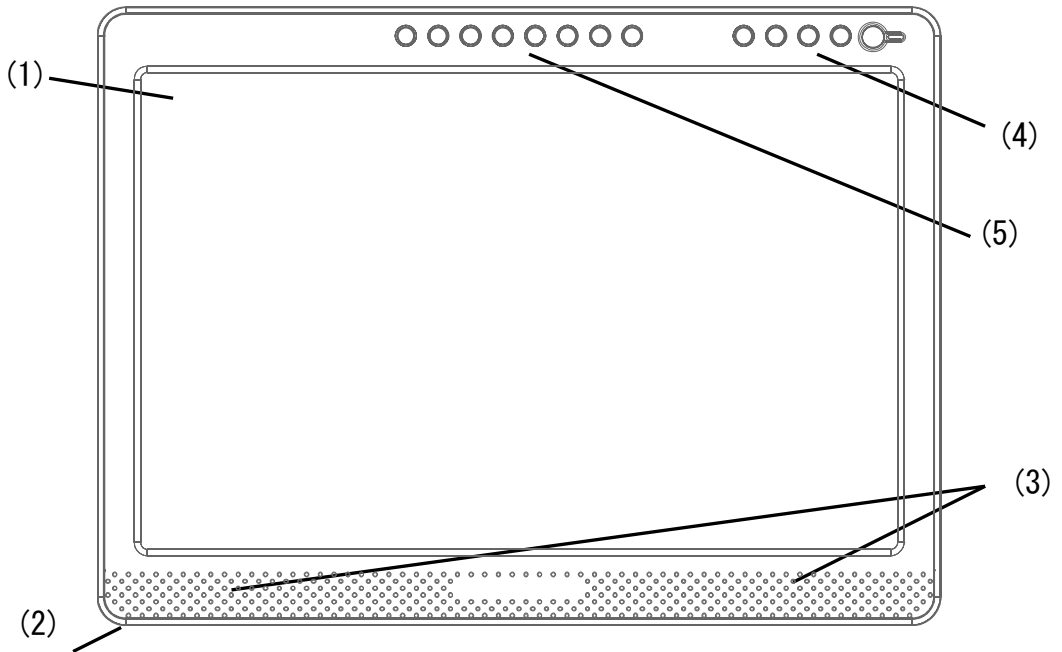

(1) LCD and tablet operating area

Receives text and graphical information entered with the stylus pen, and transmits the data to a PC.

(2) Stand (bottom of body and back)

The stand serves to hold the StarBoard in place. The LCD angle can be adjusted in the range of approx. 8° to 75°. (For details on the angle of the LCD display surface, see page 1-8 of this User's Guide.)

(3) Speakers

The supplied audio cable can be used to connect to the PC to allow audio output from the speakers.

(4) Front switch panel

These switches are used to turn the power ON/OFF, enter OSD menu settings, and adjust the volume.

(5) Function buttons

Eight standard functions used by the StarBoard software are assigned to these buttons. (For details on function button initial settings, see “1.3.4 Function Buttons” on page 1-6 of this User’s Guide.)

1.3.2 Front Switch Panel

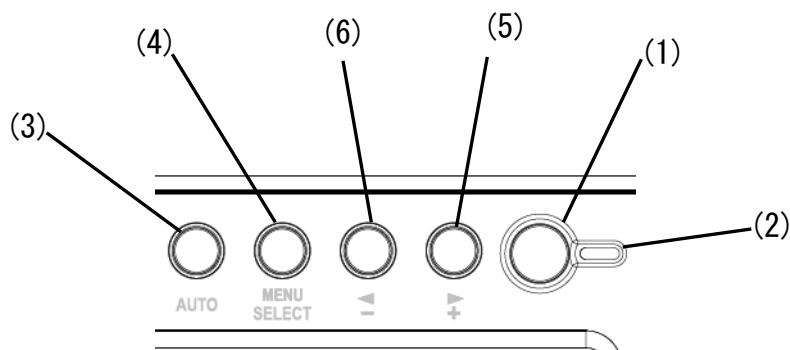

(1) Power button

This button turns the StarBoard LCD monitor ON/OFF.

(2) Power indicator

This indicator turns green when power is supplied normally to the StarBoard and an image signal is detected. It turns red when no image signal is output from the PC, or when power saving mode is on.

(3) AUTO button

This button is used to automatically adjust the screen display.

(4) MENU/SELECT button

This button is used to display the OSD menu. Press it after making menu selections to apply those.

(5)  button

This button is used to toggle muting ON/OFF. It is also used to select OSD menu options and change settings.

(6)  button

Brightness can be adjusted by the (+) and (-) buttons after pressing the (-) button.

This button is also used to select OSD menu options and change setting values.

- For details on using the OSD menu, see “2.3 Using the OSD Menu” on page 2-6 of this User’s Guide.

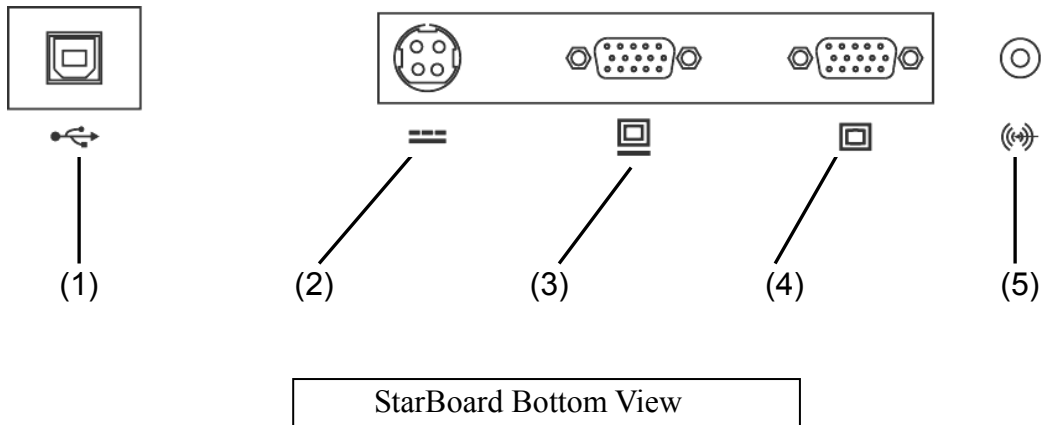
1.3.3 Connector Panel**(1) USB port**

A USB cable is connected here.

(2) Power port

The AC adapter is connected here.

(3) VGA output port

This port is used to connect external devices such as a projector via RGB cable to output video displayed on the StarBoard.

(4) VGA input port

This port is used to connect a PC via RGB cable to display images from the PC.

(5) Audio input port

This port is used to output PC audio from the StarBoard speakers. The supplied audio cable is connected to this port.

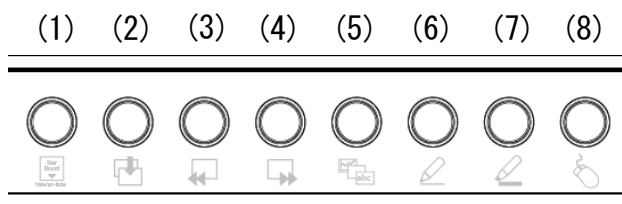
1.3.4 Function Buttons

- | | |
|--|---|
| (1) ToolBar hide/un-hide
Hides/displays StarBoard Software
ToolBar. | (5) Topic list
Hides/displays the Topic List. |
| (2) New blank page
Adds a new blank page. | (6) Solid pen
Switches to solid pen. |
| (3) Previous page
Displays the page before the
currently displayed page. | (7) Fluorescent marker pen
Switches to fluorescent marker pen. |
| (4) Next page
Displays the page after the currently
displayed page. | (8) PC screen
Launches PC Operation mode, in
which operations on the PC screen
are done via the pen instead of the
mouse. |

- For details on using the function buttons, see the StarBoardSoftware Function Button Settings Help.

1.4 Assembly and Setup

Keep the following points in mind when installing the StarBoard.

Select a stable, flat location.

Avoid installing in locations that are dusty, extremely hot, cold, or humid. Also avoid installing in locations exposed to direct sunlight.

1.4.1 Adjusting the Stand



CAUTION

Hold the body firmly and slide the stand slowly when adjusting it.

When adjusting the stand, if you pull up the lever without holding onto the body, the body may move suddenly, resulting in unexpected injuries or damage to the body.

Follow the procedure shown below to adjust the stand.

(1) Pull up the stand lever.

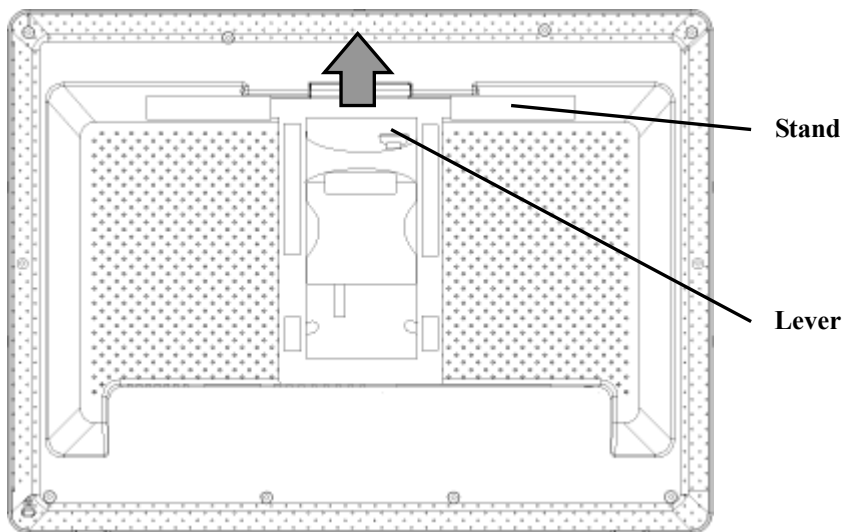

(2) Slide the stand to the desired angle, and release the lever.

Use the screen at an easily viewable angle, taking into account external light and ceiling lighting, which may reflect off the screen.

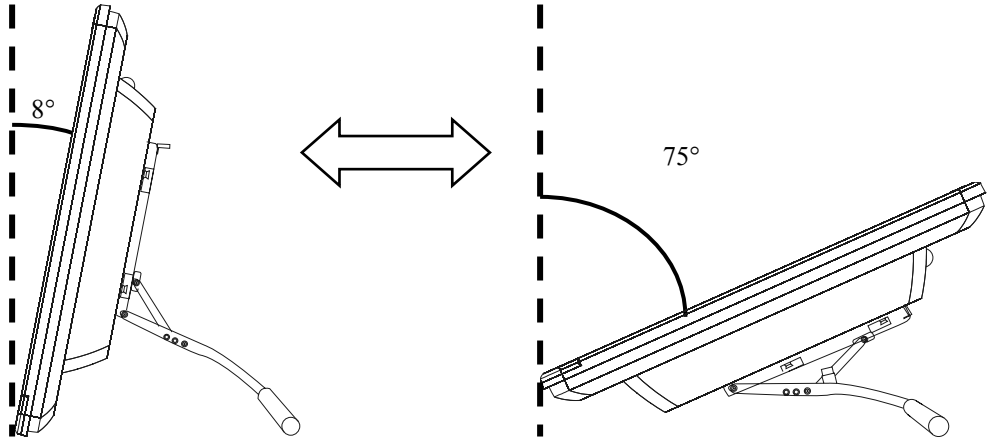

(3) Check that the lever and stand are secure.

1.4.2 How to Use the Pen Holder

The T-19WX comes with a pen holder on the back side.

Store the stylus pen in the pen holder when not in use.

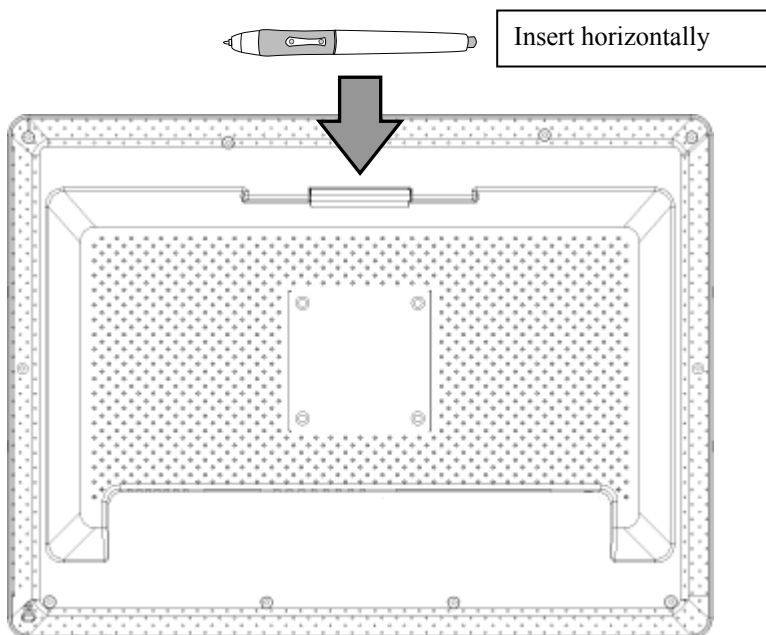

1.4.3 Connection Procedure

Before Connecting Equipment

Install the StarBoard Software on your PC before connecting equipment. Equipment may not function normally if connections are made without first installing the software.

⚠ WARNING

Use the AC Adaptor supplied with this product.

Use only AC Adaptor or power cables specified by the manufacturer. Use of improper adaptors or cables can damage the product or cause a fire.

NOTICE

Securely connect the earth to the earth terminal.

Failing to do so may result in an electric shock or malfunction.

Follow the procedure below to connect the PC and StarBoard.

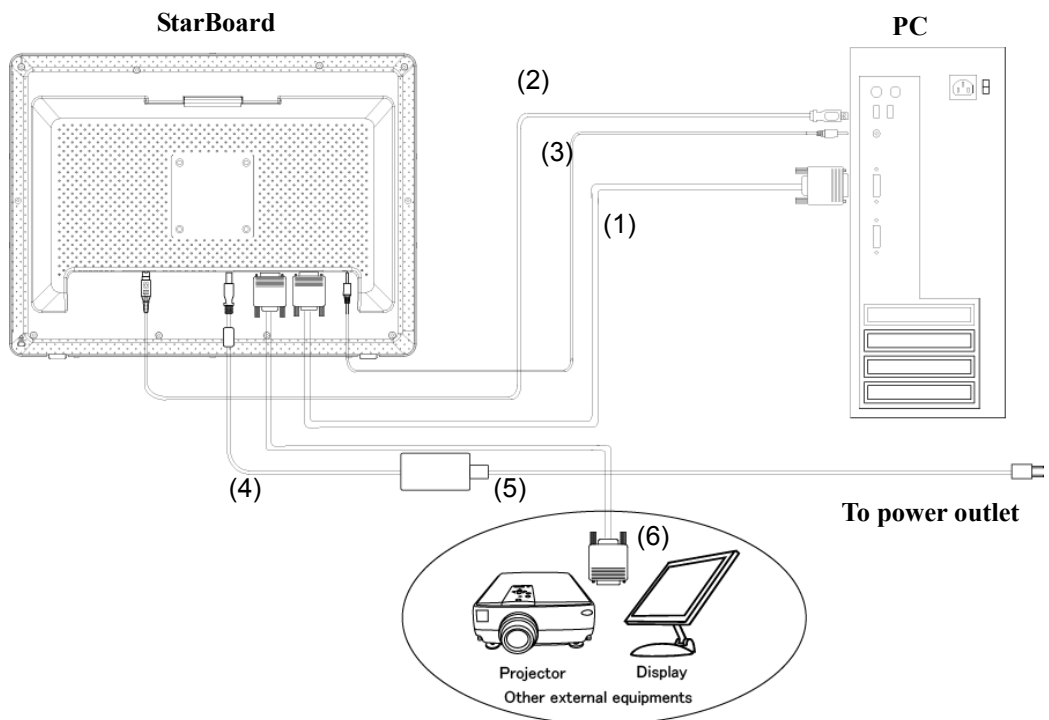

- (1) Connect the RGB cable to the VGA input port on the side of the StarBoard, and tighten the screws to fasten. Connect the other end of the cable to the PC VGA port, and tighten the screws to fasten.
- (2) Connect the USB cable to the USB port on the side of the StarBoard. Connect the other end of the cable to a USB port on the PC.
- (3) Connect the audio cable to the audio input port on the side of the StarBoard. Connect the other end of the cable to the audio output port on the PC. (Do this only if you plan to use the StarBoard's built-in speakers.)
- (4) Connect the AC adapter connector to the StarBoard power connector.
- (5) Connect the power cable to the AC adapter, then plug the power plug into power socket.
- (6) If outputting the StarBoard screen to external equipment, connect the RGB cable to the VGA output port. Connect the other end of the cable to an input port on the external video equipment.

How to install StarBoard Software

For details on how to install StarBoard software, see "StarBoard Software Installation" in StarBoard Software x.x User's Guide

2. Usage Procedures

This section describes the basic procedures for using StarBoard. For information on using advanced StarBoard features, see the StarBoard Software x.x. User's Guide, or StarBoard Software x.x Online Help.

2.1 Turning the StarBoard On

This section describes how to turn the StarBoard on.

- (1) Turn on the StarBoard power.

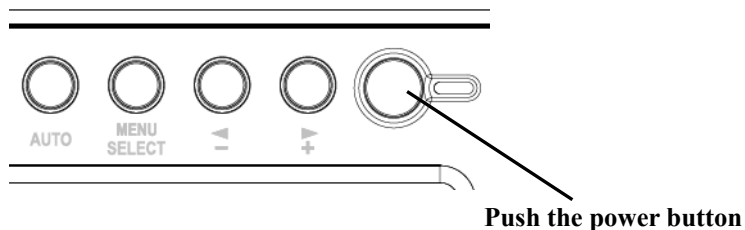

- (2) Turn on the PC and allow Windows to start.
- (3) The StarBoard Software starts automatically. (If the Startup checkbox was not checked during the shortcut creation process when the software was installed, the StarBoard Software will not start when Windows opens. In such cases, start the StarBoard Software manually. For further details, see the StarBoard Software x.x User's Guide, or StarBoard Software x.x Online Help.)

Manual Startup

Either select **Start** → **Programs** → **StarBoard Software** →  **StarBoard Software**, or double-click the StarBoard Software icon on the desktop. (The StarBoard Software icon is not created on the desktop unless the Desktop checkbox is selected during the shortcut creation process when the software is installed.)

2.2 Using the Stylus Pen

This section describes how to use the StarBoard stylus pen.

2.2.1 How to Use the Stylus Pen

The stylus pen has a power switch. Battery life can be prolonged by switching the power switch OFF when not in use. To draw characters and figures using the stylus pen, set the power switch of the stylus pen to the ON position.

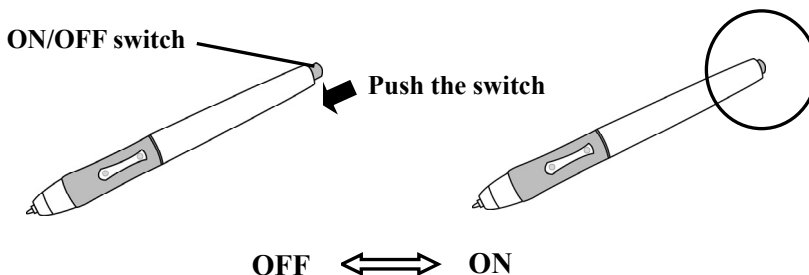

2.2.2 Basic Stylus Pen Operations

The stylus pen can be used in the same way as a mouse. Under the stylus pen's default settings, the pen tip button is set to correspond to the left mouse button. When Windows is open, the pen tip button may be used to perform the following mouse actions.

- Clicking
Press the pen tip against the display with a suitable amount of force and then release it quickly.
- Double-clicking
Press the pen tip against the display with a suitable amount of force and then release it, two times in a row.
- Dragging
Press the pen tip against the display with a suitable amount of force and then move the pen while keeping it pressed against the display (without releasing it from the display).

The permitted stylus pen input angle range is 30° in any direction from a position where the stylus pen is perpendicular to the display surface. Note that if the pen is tilted at an angle greater than 30°, its coordinates may not be input correctly.

2.2.3 Stylus Pen Settings

The stylus pen has one pen tip button, and two side buttons. Mouse actions can be assigned to these three buttons. The default button settings are summarized in the following table.

Button	User action	Corresponding mouse action
Pen tip	Press the pen tip against the display.	Mouse left-click
Side Button No. 0	Press the button with the pen tip slightly removed from the screen (5 mm or less).	Mouse left double-click
Side Button No. 1	Same as above.	Mouse right-click

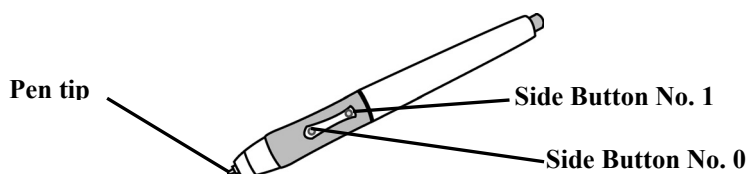

For details on changing the button settings, see the StarBoard Software x.x Online Help.

2.2.4 Changing the Battery in the Stylus Pen

The stylus pen contains a single AAA alkaline dry cell battery. If the pen begins to operate erratically (e.g., if pen input is cut off), change the battery as described below. Note that battery life is approximately 1,800 hours under normal usage. If the residual quantity of a battery decreases, the centre of a side button will light up red. If the centre of a side button lights up red, change the battery as described below.

- (1) Turn the stylus pen grip to separate the two halves.

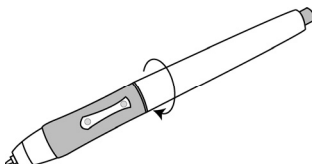

- (2) Remove the AAA alkaline dry cell battery contained in the grip, and insert a new cell with the positive side facing the pen tip.

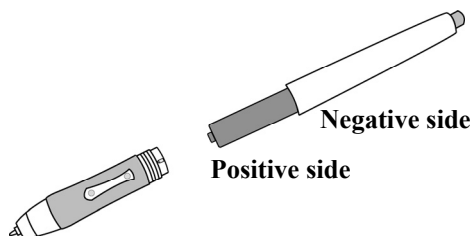

- (3) Put the stylus pen back together.

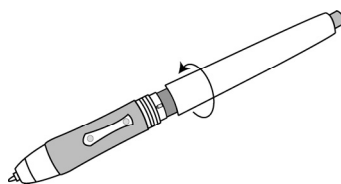

NOTICE

When changing the battery, be careful not to close the pen's rear part too forcefully.

If too much force is applied when closing the rear part of the stylus pen, the pen may be damaged.

2.2.5 Replacing the Stylus Pen Tip

When the stylus pen tip wears down and becomes too short, replace it as described below.

- (1) Using the special pin set, remove the stylus pen tip.

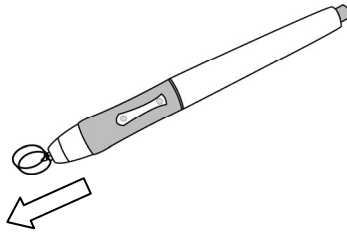

- (2) Insert a new pen tip into the stylus pen.

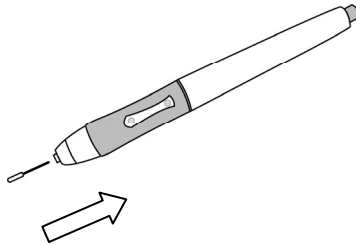

2.3 Using the OSD Menu

The OSD menu is used when adjusting the StarBoard LCD screen. OSD is an abbreviation for On-Screen Display. The OSD feature allows you to view and adjust the settings for the display on the screen.

2.3.1 OSD Buttons and Their Functions

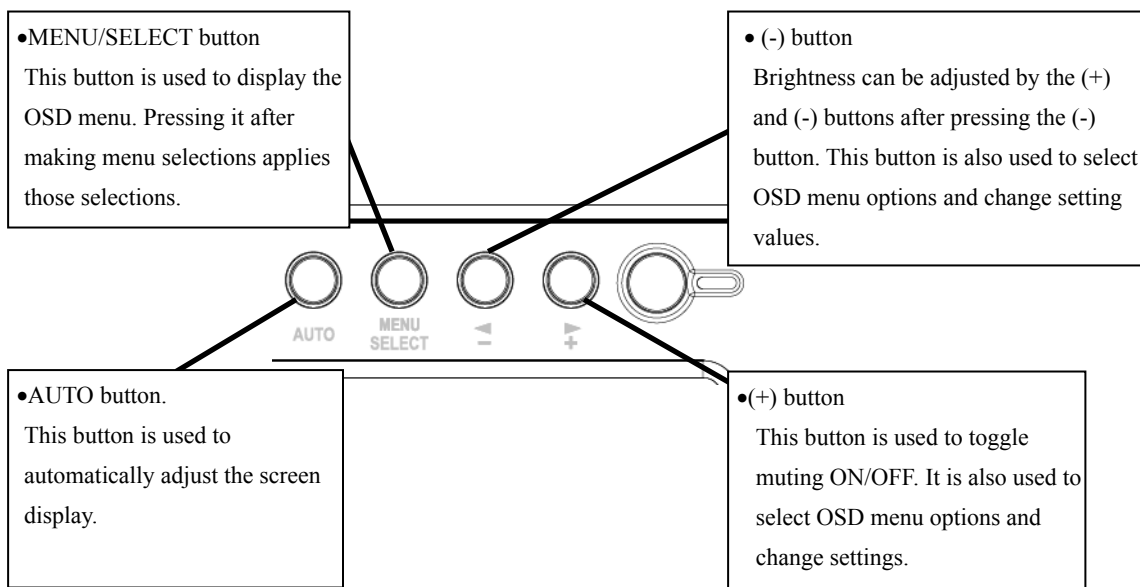

	BRIGHTNESS	
	CONTRAST	
	LCD ADJUSTMENT	
	COLOR TEMPERATURE	
	ECO MODE	
	LANGUAGE	
	OTHER SETUP	
	EXIT	
		INPUT: ANALOG
		RESOLUTION: 1280 x 1024
		FREQUENCY: 60Hz
		COLOR: 7200K
		VOLUME: 50
		OSD TIMEOUT: 24

OSD Menu

■ Adjustment procedure

- (1) Press the MENU/SELECT button to display the OSD menu.
- (2) Use the (+) button and (-) button to select a menu item.
- (3) Press the MENU/SELECT button to confirm the selection.
- (4) Use the (+) button and (-) button to adjust the value, and MENU/SELECT to select that value.
- (5) To close the OSD menu, leave buttons un-pressed for a set amount of time (adjustable), or select EXIT from the menu screen. (If closing by not pressing buttons, setting changes made up to then will be applied when the OSD closes.)

2.3.2 OSD Adjustment Options

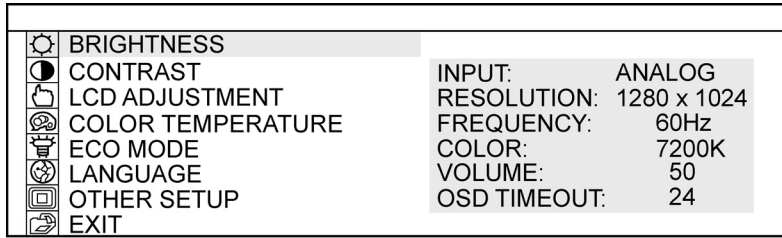

(1) BRIGHTNESS

Used to adjust screen brightness. (0-100)

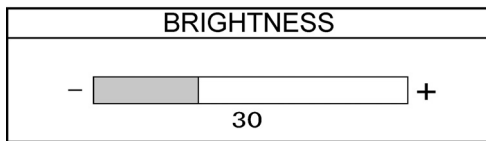

(2) CONTRAST

Used to adjust colour contrast. The larger the value, the brighter the image will be. (0-100)

(3) LCD ADJUSTMENT

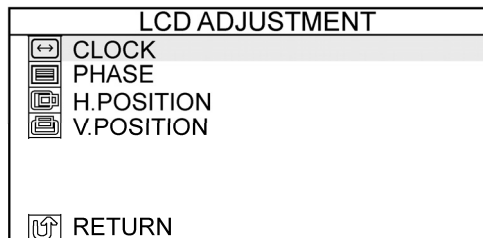

- CLOCK : Used to adjust screen size. (0-100)
- PHASE : Used to adjust the sampling timing (phase) for converting the analogue input signal to a digital input signal. (0-63)
- H.POSITION : Used to change the horizontal position of the screen. (0-100)
- V.POSITION : Used to change the vertical position of the screen. (0-100)
- RETURN : Used to return to the previous page.

(4) COLOUR TEMPRATURE

Used to adjust the colour temperature of the screen.

(9300K, 6500K, USER, SRGB)

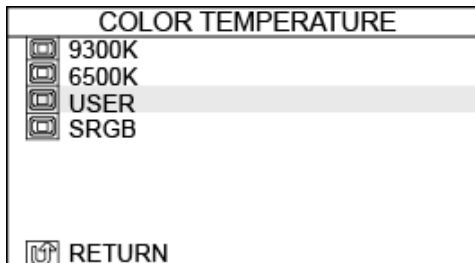

USER : Used to adjust the red, green, and blue colours of the screen.
(0-100)

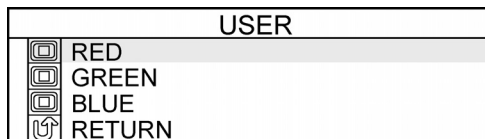

RETURN : Used to return to the previous page.

(5) ECO MODE

Used to turn the ECO mode ON, and limit brightness setting from 0 to 20 to reduce power consumption.

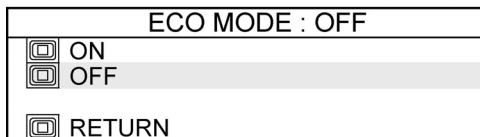

RETURN : Used to return to the previous page.

(6) LANGUAGE

Used to select the display language. The following languages are available: Japanese, English, French, German, Spanish, Italian, and Chinese.

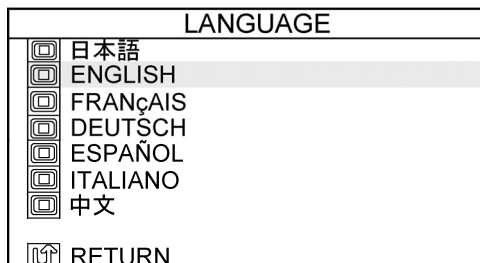

RETURN : Used to return to the previous page.

(7) OTHER SETUP

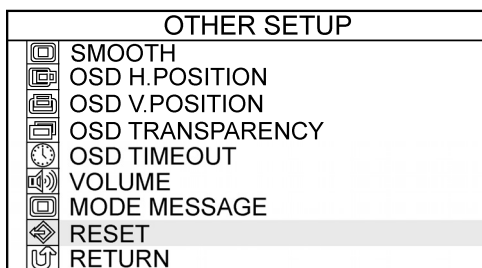

- SMOOTH : Used to adjust the smoothness of the image. (0-3)
Use is not possible at a resolution of 1440 × 900 (WXGA+).
- OSD H.POSITION : Used to adjust horizontal position of OSD window. (0-100)
- OSD V.POSITION : Used to adjust vertical position of OSD window. (0-100)
- OSD TRANSPARENCY : Used to turn OSD window background transparency ON/OFF.

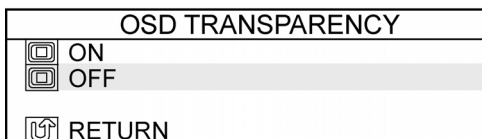

- OSD TIMEOUT : Used to set the amount of time before the OSD menu closes automatically. (0-60)
- VOLUME : Used to adjust the speaker volume. (0-100)
- MODE MESSAGE : Used to turn the screen resolution display ON/OFF.

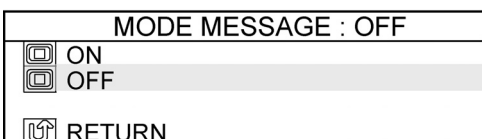

- RESET : Used to reset OSD menu settings to their default values.
- RETURN : Used to return to the previous page.

(8) EXIT

Used to exit the OSD menu.

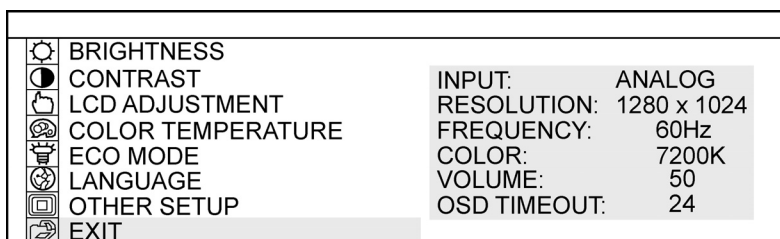

3. Appendix

3.1 Troubleshooting

First, check adjustments and handling methods and check for poor cable connections.

Those are often the causes of problems when nothing is actually broken.

Screen display-related problems

In this case	Check this	And do this
PC screen does not display on StarBoard.	Is the PC power on?	To deal with problem see the PC manual and other documentation.
	Is the RGB cable connected to the PC and StarBoard properly?	Connect the RGB cable correctly. (For details on how to connect, see “1.4.3 Connection Procedure” on page 1-9 of this User’s Guide.)
	For laptop PCs, is external (RGB) output selected?	Connect cable after starting up the PC, or switch to external (RGB) output at the screen display mode settings. (Method of switching differs by PC. For instructions, see the PC manual and other documentation.)
	Was LCD and monitor switching done right (may be assigned to a function key)?	Set so LCD and monitor are both selected, or that just the monitor is selected. (For details on selection, see the PC manual and other documentation.)
	Other	Contact technical support.

StarBoard Software-related problems

In this case	Check this	And do this
StarBoard is not recognized.	Is the USB cable connected properly?	Connect USB cable to PC. (For details on how to connect, see “1.4.3 Connection Procedure” on page 1-9 of this User’s Guide.)
	Was system startup done in the proper order?	Start up system in proper order. (For details on how to start up the system, see ”2.1 Turning the StarBoard On” on page 2-1 of this User’s Guide.)
	StarBoard Software may be damaged or did not install correctly.	Uninstall StarBoard Software, and then reinstall. (For details on how to install StarBoard software, see “StarBoard Software Installation” in StarBoard Software x.x User’s Guide)
	Other	Contact technical support.

Stylus pen-related problems

In this case	Check this	And do this
Stylus pen does not operate.	StarBoard Software may be damaged or may not be installed correctly.	Uninstall StarBoard Software, and then reinstall. (For details on how to install StarBoard software, see “StarBoard Software Installation ” in StarBoard Software x.x User’s Guide)
	Is battery worn out?	Replace stylus pen battery. (For details on how to change the battery, see “2.2.4 Changing the Battery in the Stylus Pen” on page 2-4 of this User’s Guide.)
	Is pen tip worn down?	Check if the pen tip is worn down or is too short. (For details on how to replace the stylus pen tip, see “2.2.5 Replacing the Stylus Pen Tip” on page 2-5 of this User’s Guide.)
	Are there any electronic devices located nearby the StarBoard such as microwave ovens or radio transmitters that emit electromagnetic noise?	This product is susceptible to electromagnetic noise, so use the StarBoard away from devices that emit noise.
	Other	Restart Windows and StarBoard Software. Contact technical support.
Stylus pen tip and pen cursor positions do not match.	Did you calibrate the pen position correctly?	Calibrate the pen position correctly. (For details on how to calibrate the pen, see “Calibration” in the StarBoard Software x.x User’s Guide)
	Other	Contact technical support.

Function button-related problems

In this case	Check this	And do this
Function buttons don't operate.	Is the USB cable connected properly?	Connect USB cable to PC. (For details on how to connect, see "1.4.3 Connection Procedure" on page 1-9 of this User's Guide.)
	Is the StarBoard Software running?	Function button features require the StarBoard Software. Use them with the StarBoard Software running. (For details on how to use the StarBoard Software, see the StarBoard Software x.x User's Guide.)
	StarBoard Software may be damaged or may not be installed correctly.	Uninstall StarBoard Software, and then reinstall. (For details on how to install StarBoard software, see "StarBoard Software Installation" in StarBoard Software x.x User's Guide.)
	Are there any electronic devices located nearby the StarBoard such as microwave ovens or radio transmitters that emit electromagnetic noise?	This product is susceptible to electromagnetic noise, so use the StarBoard away from devices that emit noise.
	Other	Restart Windows and StarBoard Software. Contact technical support.

3.2 System Specifications

Item		Specification
Product name		StarBoard T-19WX
Model No.		70.53K02G00x* (StarBoard T-19WX), AH00219
Display characteristics	Driver type	Active-Matrix Liquid Crystal Display (TFT)
	Effective screen size	19 inches 408.24 mm (W)×255.15 mm (H)
	Resolution	1440×900 (WXGA+)
	Pixel pitch	0.2835×0.2835 mm
	Standard colours	16,700,000 colours
	Brightness	300 cd/m ²
	Contrast ratio	1000 : 1
	Viewing angles	right 85°, left 85°, up 80°, down 80°
Digitiser characteristics	Input system	Electromagnetic induction
	Pen	Stylus pen (Uses one AAA alkaline dry cell; battery life: approximately 1800 hours**)
	Reading accuracy	± 0.5 mm
	Tracking speed	Approximately 130 points per second
	Interface	USB interface (USB1.1 compliant)
Environmental conditions	Temperature	During use: 50°F to 95°F (10°C to 35°C) in storage: -4°F to 140°F (-20°C to 60°C)
	Humidity	During use: 30 to 80% (no condensation) in storage: 10 to 80% (no condensation)
Input/output		DC in VGA in Dsub 15-pin VGA out Dsub 15-pin Stereo mini-jack (stereo audio) USB
Power consumption		50 W or less (2W or less in power saving mode)
Power supply (AC adapter)		Input AC 100 – 240 V, 50/60 Hz, 1.5 A Output DC 12 V, 5.0 A
External dimensions		462.0 (W)×348.4 (H)×60.0 (D) mm (without stand)
Weight		Approx. 4.6 kg
Stand adjustment		Adjustable in the range of 8° to 75°
VESA Mount		75mm×75mm
Safety Standards, etc.		FCC Class B, CE, VCCI Class B, UL / cUL, TUV
Software Required		StarBoard Software 8.11 or newer version

* The term “x” as used in this manual denotes the model No. of the product.

** Battery life varies depending on the temperature and humidity of the usage environment.

Compatible Modes

Standard	Resolution	Vertical Refresh (Hz)	Horizontal Scan (KHz)
Dos-Mode	720 × 400	70	31.5
VGA	640 × 480	60	31.5
	640 × 480	72	37.9
	640 × 480	75	37.5
SVGA	800 × 600	60	37.9
	800 × 600	72	48.1
	800 × 600	75	46.9
XGA	1024 × 768	60	48.4
	1024 × 768	70	56.5
	1024 × 768	70	56.5
SXGA	1280 × 1024	60	64.0
	1280 × 1024	75	80.0
WXGA+	1440 x 900	60	55.9
	1440 x 900	75	70.6

3.3 How to Take Care of the StarBoard

Please clean your StarBoard periodically so it will continue to work for a long time.

(1) Cleaning and care

- Use a dry, soft cloth to clean the StarBoard display surface. Do not use detergents.
- Use a diluted detergent without abrasives to clean the StarBoard cabinet area. Do not use undiluted detergent; rather, mix with water and soak a soft cloth in the mixture. Wring out cloth thoroughly before wiping.
- Be careful not to scratch the StarBoard surface with fingernails or other hard objects. That or bumping the StarBoard can damage it.
- Never use gasoline, thinner, or other solvents. That can cause the cabinet to degenerate and printed areas to peel off.

3.4 Consumables

- (1) Pen tips for Stylus pen
- (2) AAA alkaline dry cell

Enquire at the place of purchase or with technical support for information on how to get replacements.

3.5 LCD Panel

- (1) Please note that even though the LCD panel is produced using extremely high-precision technology, there may be some dots that are always on or always off, but this is not a malfunction.
- (2) The lifespan of the backlight used in the LCD panel is approximately 50,000 hours. The backlight used in the LCD panel has a limited lifespan. Contact technical support if the screen becomes dark, flickers, or will not light up.

3.6 Provisions of Product Warranty

1. During the free warranty service period, if a malfunction occurs during normal use, the malfunction will be corrected without charge, according to the provisions of the warranty. Furthermore, if the customer registration card accompanying the warranty is not returned to our company, the customer information will not be registered, so free repairs might be unavailable. After receiving this product, please immediately fill out and return this customer registration card.
2. The warranty coverage is as listed in the following table:

Product Name	Part Name	Warranty Coverage
StarBoard	19-inch LCD monitor	+
	Stylus pen	+
	RGB cable	+
	USB cable	+
	AC adapter	+
	Power cable	+
	Audio cable	+
	Stand	+
Replacement tip for Stylus pen		–
Other parts		–

Legend: + Covered by warranty (excluding wear and physical damage)
 – Not covered by warranty

3. Please refer to the warranty about this product's warranty service period.
4. Even during the warranty period, there will be a repair charge in the following cases:
 - (1) If the registration card accompanying the warranty is not returned to our company.
 - (2) If the warranty is not presented.
 - (3) If specified fields on the registration card accompanying the warranty are not completed, or if the wording has been changed without authorization.
 - (4) The warranty applies only to the original purchasers. (It does not apply to a third party to whom the customer resold this product.)
 - (5) In the event of a malfunction or damage resulting from the customer's improper handling (e.g., a fall, impact, etc., caused by the customer during transportation or movement).
 - (6) In the event of problems resulting from handling contrary to the handling and precautions mentioned in this user's guide.
 - (7) In the event of failure or damage resulting from abnormal voltages, pollution or other natural disasters (e.g., fire, earthquake, lightning).

- (8) In the event of a malfunction in this product caused by the connection to this product of equipment other than the equipment specified by our company.
 - (9) In the event that there is no abnormality in this product, but a defect in a part other than this product was detected or remedied.
 - (10) In the event of ordinary wear and tear, wear, deterioration, etc., of consumables, even during normal use.
5. If this product malfunctions, review the contents of this user's guide. If the problems remain irreparable, contact technical support. Technical support will determine whether or not the product must be repaired, so please contact them. If the customer sends the product to our company without RMA (Return Merchandise Authorization) number, it might not be covered by warranty.
 6. As a rule, the customer is responsible for shipping charges required to send all or part of the product for repair, etc. Our company will assume responsibility for the return shipping to the customer.
 7. This warranty does not cover labour fees for repair-associated equipment assembly or disassembly.
 8. Incidental damage caused by the failure of this product (e.g., loss of profit that should have resulted from the use of this product) is outside the scope of this warranty.
 9. The aforementioned provisions define this warranty, and they supersede those of all express or implied warranties that include legal defect liability.